

**TONTARRA**

ENDOSCOPY

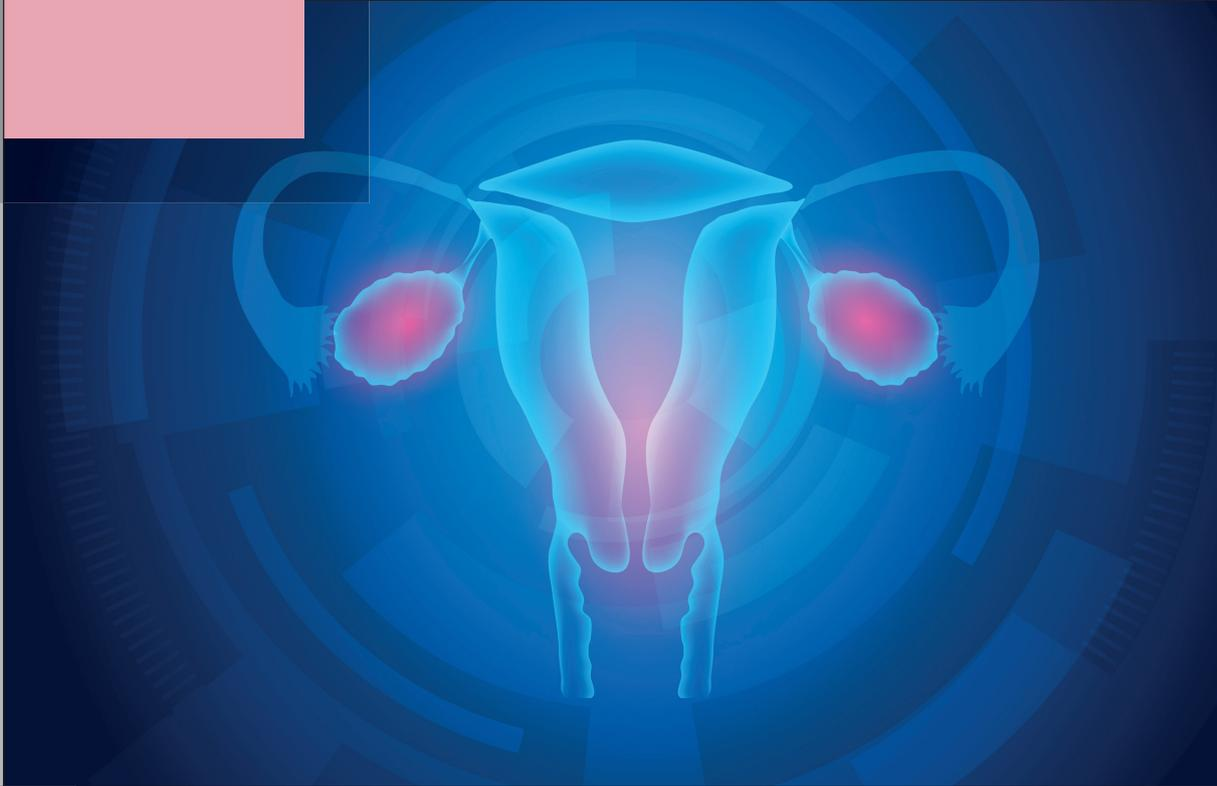
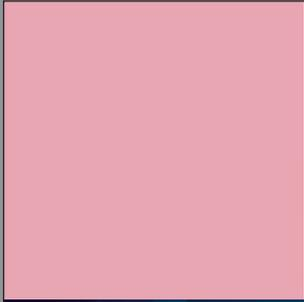

GYNECOLOGY

## ABOUT US

For more than 50 years “made by TONTARRA, Germany” is a synonym for state-of-the-art surgical and endoscopic instruments and equipment.

This success and the international recognition of the skillfulness in surgical and endoscopic instrument making of Tontarra Medizintechnik GmbH are based on our commitment to medical innovation, mastery in manufacturing, and a strong focus on our continuing tradition of excellence.

The confidence in our surgical and endoscopic lines as expressed by our international customers, distribution- and OEM-partners are a driving force to face and meet new challenges.

# TONTARRA



Indispensable ‘tools’ for maturing new ideas into high-precision surgical instruments of highest precision include our state-of-the-art manufacturing facility and production processes, and especially the comprehensive technical know-how, ingenuity and strong commitment of our entire team.

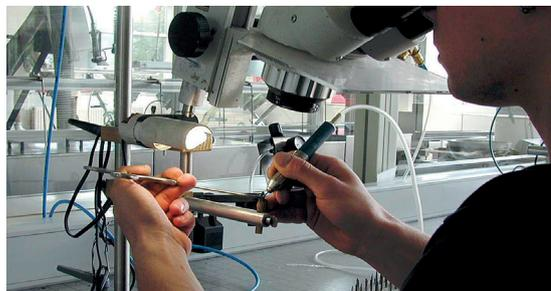

## ICONS – OVERVIEW



Function length



LuerLock



Quick Lock



For use with sheath in size



Round sheath



Oval sheath



Drop style sheath



Continuous flow

**TABLE OF CONTENT**

▶ Quick Lock connecting system	4	▶ Mini-Resectoscopy Ø 2.9 mm	41 – 46
		17.5/18.5 Fr.	
▶ Telescopes HD / HD+ / HD+2	5 – 8	▶ Instruments for Gynecology	47 – 54
Light guide cables & Connectors		Endoscopic Standard Instruments	
		Laparoscopic Standard Instruments	
▶ Hysteroscopy	9 – 20	▶ HF Generator and	55 – 58
		Connection cables	
▶ Resectoscopy Ø 4.0 mm	21 – 36	▶ Accessories	59 – 61
24/26 Fr. & 27/28.5 Fr.		General Gynecologic Accessories	
		Maintenance, Storage & Sterilization	
▶ Resectoscopy Ø 2.9 mm	37 – 40	▶ Index	62 – 63
19/22 Fr.			



## THE QUICK LOCK CONNECTING SYSTEM

The main feature of the Quick Lock connecting system is that the sheath which is rigidly coupled with the connecting system can be very easily assembled and disassembled. Due to the spring locking the centering of the inner and outer sheaths is optimized compared to the established Bayonet-type instruments.

The precise labeling on the instrument makes it easy to operate the connecting system.

The Quick Lock system is characterized by a smooth running take apart and a tight sealing of the two sheaths connected.





# TELESCOPES

- ◀ HD
- ◀ HD+
- ◀ HD+2

Light guide Cables & Connectors

## GYNECOLOGY TELESCOPES HD+, HD+2



- ▶ Ø 4.0 mm
- ▶ Compatible with most instrument- and camera systems

The „See & Treat“ approach has become a synonyme for office hysteroscopy. This already implies that the image quality is an essential criteria for each hysteroscopist: the clear visualization of a patients pathology is not only a prerequisite for secure diagnostics and the choice of intervention, but as well vital for a successful performance of therapeutic treatment.

TONTARRA Telescopes feature an excellent imaging quality for diagnostics and therapy, and support camera systems and instruments of nearly all well-known brands.



### HYSTEROSCOPES [autoclavable]

▶ Ø 4.0 mm

Description			Art. No.	<ul style="list-style-type: none"> <li>• <b>Field of view: 91°</b></li> <li>• Ø 4.0 mm is the traditional size used in diagnostic hysteroscopy, and our hysteroscope has been specially designed to achieve an extraordinary wide field of view (91°)</li> <li>• Available in 4 different viewing directions</li> <li>• Not to be used in combination with resectoscopy sheaths</li> </ul>
Hysteroscope HD+	▶ Ø 4.0 mm; 0°	FL 300 mm	601-114-00HD	
Hysteroscope HD+2	▶ Ø 4.0 mm; 0°	FL 300 mm	601-114-00HD2	
Hysteroscope HD+	▶ Ø 4.0 mm; 12°	FL 300 mm	601-114-12HD	
Hysteroscope HD+2	▶ Ø 4.0 mm; 12°	FL 300 mm	601-114-12HD2	
Hysteroscope HD+	▶ Ø 4.0 mm; 30°	FL 300 mm	601-114-30HD	
Hysteroscope HD+2	▶ Ø 4.0 mm; 30°	FL 300 mm	601-114-30HD2	
Hysteroscope HD+	▶ Ø 4.0 mm; 70°	FL 300 mm	601-114-70HD	
Hysteroscope HD+2	▶ Ø 4.0 mm; 70°	FL 300 mm	601-114-70HD2	

### TELESCOPES FOR RESECTOSCOPY IN GYNECOLOGY [autoclavable]

▶ Ø 4.0 mm

Description			Art. No.	<ul style="list-style-type: none"> <li>• <b>Field of view: 70°</b></li> <li>• For use in gynecologic resectoscopy</li> <li>• Available in four different viewing directions</li> </ul>
Telescope HD+	▶ Ø 4.0 mm; 0°	FL 300 mm	601-104-00HD	
Telescope HD+2	▶ Ø 4.0 mm; 0°	FL 300 mm	601-104-00HD2	
Telescope HD+	▶ Ø 4.0 mm; 12°	FL 300 mm	601-104-12HD	
Telescope HD+2	▶ Ø 4.0 mm; 12°	FL 300 mm	601-104-12HD2	
Telescope HD+	▶ Ø 4.0 mm; 30°	FL 300 mm	601-104-30HD	
Telescope HD+2	▶ Ø 4.0 mm; 30°	FL 300 mm	601-104-30HD2	
Telescope HD+	▶ Ø 4.0 mm; 70°	FL 300 mm	601-104-70HD	
Telescope HD+2	▶ Ø 4.0 mm; 70°	FL 300 mm	601-104-70HD2	

## GYNECOLOGY TELESCOPES HD



- ▶ Ø 2.9 mm / Ø 2.0 mm
- ▶ Compatible with most instrument- and camera systems

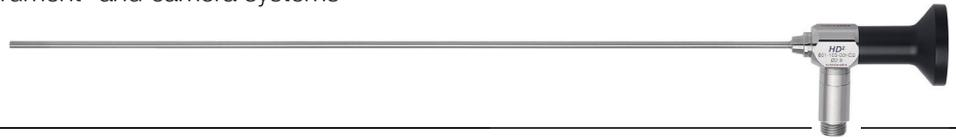

### TELESCOPES FOR GYNECOLOGY [autoclavable]

▶ Ø 2.9 mm [also for use in Laparoscopy and Urology]

Description	Art. No.	
Telescopes HD+2 ▶ Ø 2.9 mm; 0° FL 300 mm	601-103-00HD2	· <b>Field of view: 80°</b> · Compatible with most instrument- and camera systems
Telescopes HD+2 ▶ Ø 2.9 mm; 12° FL 300 mm	601-103-12HD2	
Telescopes HD+2 ▶ Ø 2.9 mm; 30° FL 300 mm	601-103-30HD2	



### TELESCOPES FOR GYNECOLOGY [autoclavable]

▶ Ø 2.0 mm [also for use in Urology]  
▶ Fibre telescopes

Description	Art. No.	
Telescopes HD ▶ Ø 2.0 mm; 0° FL 187 mm	601-102-00	For diagnostic miniature hysteroscopes or mini operative systems, f.e. TONTARRA's hysteroscopy continuous flow operating sheaths for Ø 2.0 mm telescopes.
Telescopes HD ▶ Ø 2.0 mm; 30° FL 187 mm	601-102-30	
Telescopes HD ▶ Ø 2.0 mm; 0° FL 260 mm	601-112-00	
Telescopes HD ▶ Ø 2.0 mm; 30° FL 260 mm	601-112-30	
Telescopes HD ▶ Ø 2.0 mm; 0° FL 300 mm	601-132-00	
Telescopes HD ▶ Ø 2.0 mm; 30° FL 300 mm	601-132-30	



#### “GENTLE OFFICE HYSTERO-RESECTOSCOPY” on the rise:

Contemporary Gynecology has generally shifted towards gentler treatment methods, and communication on eye-level between doctor and patient has gained importance.

TONTARRA's systems for Hystero-Resectoscopy are well in line with the demand for smaller instruments; our 16 Fr. Mini-Hystero-Resectoscope „GUBBINI“ even allows the effective resectoscopic therapy without dilatation of the cervix. This approach is not only less traumatic for the patient, but also helps to save costs, as more interventions can be performed in an office-setting.

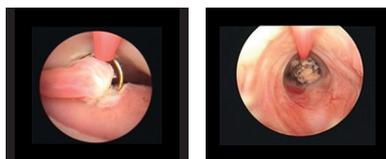

© Dr. Giampaolo Gubbini

The “Gubbini system” is also apt for resectoscopic therapy without the need for dilatation of the cervix, and can be applied to nearly all endo-uterine pathologies.

Ask for our “GUBBINI”-catalogue!



Polypectomy performed by TONTARRA's Mini-Hystero-Resectoscope “GUBBINI”, standardly equipped with a HD+2 telescope Ø 2.9 mm.



## ACCESSORIES

► Light Guide Cables & Connectors

### FIBER LIGHT GUIDE CABLES

► Stability & resistance for a long life time

Description	Standard Cold Light Line	HTT High Temperature Technology Line	HP High Performance Line
<b>Cold light sources</b>	<b>HALOGEN</b> <i>careful w/Xenon light!</i>	for all cold light sources (excellent light transmission) optimized for <b>XENON</b>	optimized for <b>LED</b>
<b>Sizes</b>	<b>Art. No.'s</b>		
Ø 4.9 x 1800 mm Length		540-815-18	
Ø 4.9 x 2300 mm Length		540-815-23	
Ø 4.9 x 3000 mm Length		540-815-30	
Ø 4.9 x 5000 mm Length		540-815-50	
Ø 3.5 x 1800 mm Length	540-803-18	540-813-18	540-823-18
Ø 3.5 x 2300 mm Length	540-803-23	540-813-23	540-823-23
Ø 3.5 x 3000 mm Length	540-803-30	540-813-30	540-823-30
Ø 3.5 x 5000 mm Length	540-803-50		540-823-50
Ø 2.5 x 1800 mm Length		540-812-18	540-822-18
Ø 2.5 x 2300 mm Length		540-812-23	540-822-23
Ø 2.5 x 3000 mm Length		540-812-30	540-822-30
Ø 2.5 x 5000 mm Length		540-812-50	540-822-50
<b>Tube colours</b> The Standard colour is grey.	Only available in grey	● LL (Lilac)   ● YW (Yellow)   ● GN (Green) <b>Colour Coding made easy:</b> If you want to order one of the shown colours Lilac, Yellow or Green, please indicate the corresponding extensions shown in the column to the right (f.e. for a green cable add „GN“, the article number then reads 540-XXX-XXGN)	
Colour of introduction piece	Black	Blue	White



For further information please ask for our Light Guide Cable brochure. Cables without connector, for connectors see below.

### LIGHT CABLE CONNECTORS

Projector-Side (light input)			Telescope-Side (light output)		
Storz/Aesculap	540-890-02		TONTARRA/Storz/Aesculap/Olympus (old)	540-880-02	
Olympus/ACMI	540-890-10				
Olympus new (switch)	540-890-14		Olympus new	540-880-04	
Wolf	540-890-04		Wolf/Dyonics snap	540-880-13	
			Wolf/Dyonics clip	540-880-05	
ACMI/British/Codman	540-890-01		ACMI/British/Codman	540-880-01	

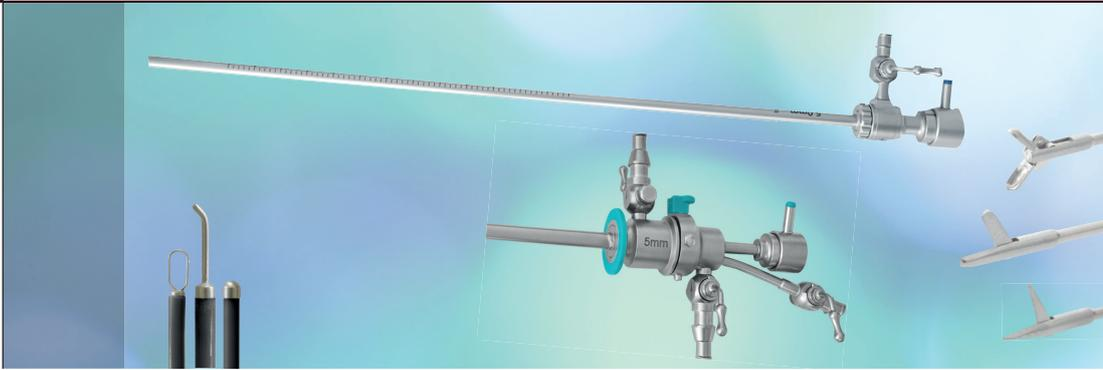

# HYSTEROSCOPY



# HYSTEROSCOPY & OPERATING SHEATHS

► Schematic overview

DIAGNOSTIC SHEATHS

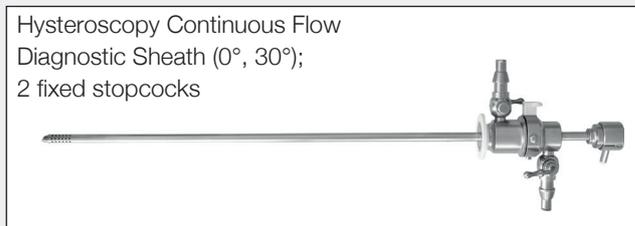
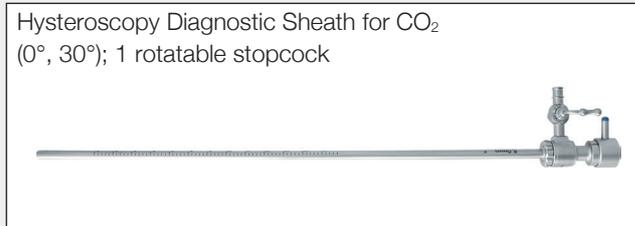

DIAGNOSTIC & OPERATING SHEATHS

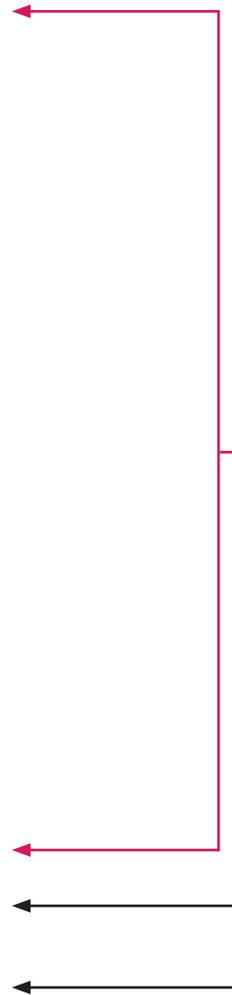
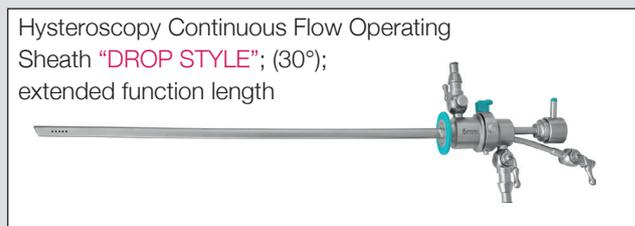
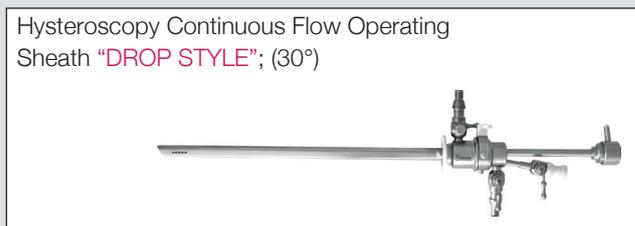



Systems and components for Ø 4.0 mm telescopes

Ø 2.9 mm telescopes

Ø 2.0 mm telescopes

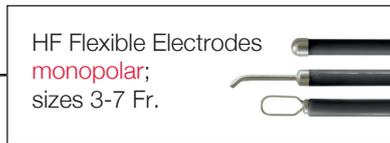

HF Connection cables (2 types):

**monopolar**

to connect flexible **monopolar** HF electrodes to HF generator

**bipolar**

to connect semi-flexible **bipolar** HF electrodes to HF generator

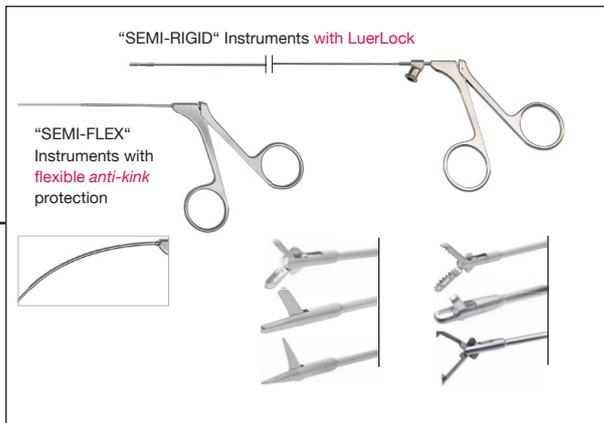

# HYSTEROSCOPY CO<sub>2</sub> DIAGNOSTIC SHEATHS



## Hysteroscopy CO<sub>2</sub> Diagnostic Sheath

- ▶ with 1 rotating stopcock
  - ▶ with Quick Lock connections
- Available for:
- ▶ Ø 4.0 mm telescopes 0° or 30°
  - ▶ Ø 2.9 mm telescopes 0° or 30°
  - ▶ Ø 2.0 mm telescopes 0° or 30°

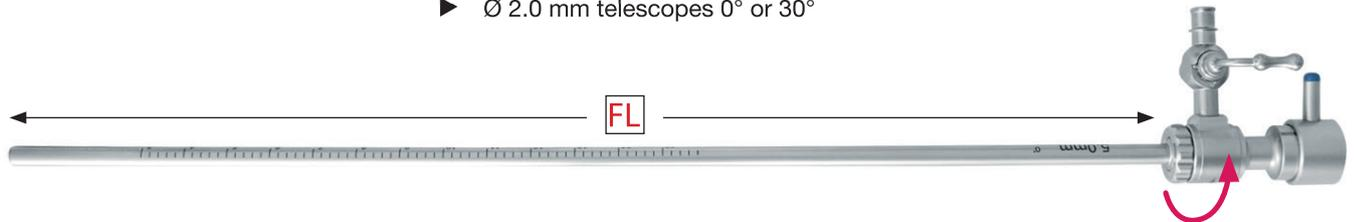

## HYSTEROSCOPY CO<sub>2</sub> DIAGNOSTIC SHEATH



<b>for Ø 4 mm telescopes ▶ Ø 5.0 mm FL 270 mm</b>			
DIAGNOSTIC SHEATH 0°	■ blue	640-010-40	 601-114-00HD, 601-114-00HD2
DIAGNOSTIC SHEATH 30°	■ blue	640-010-43	 601-114-30HD, 601-114-30HD2
OBTURATOR	■ blue	640-010-45	 Ø 5.0 mm
<b>for Ø 2.9 mm telescopes ▶ Ø 4.0 mm FL 270 mm</b>			
DIAGNOSTIC SHEATH 0°	□ white	640-010-30	 601-103-00HD2
DIAGNOSTIC SHEATH 30°	□ white	640-010-33	 601-103-30HD2
OBTURATOR	□ white	640-010-35	 Ø 4.0 mm
<b>for Ø 2.0 mm telescopes ▶ Ø 2.9 mm FL 228 mm</b>			
DIAGNOSTIC SHEATH 0°	■ red	640-010-20	 601-112-00
DIAGNOSTIC SHEATH 30°	■ red	640-010-23	 601-112-30
OBTURATOR	■ red	640-010-25	 Ø 2.9 mm
<b>for Ø 2.0 mm telescopes ▶ Ø 2.9 mm FL 270 mm</b>			
DIAGNOSTIC SHEATH 0°	■ red	640-010-27	 601-132-00

# HYSTEROSCOPY CONTINUOUS FLOW DIAGNOSTIC SHEATHS



## Hysteroscopy Continuous Flow Diagnostic Sheath

- ▶ with 2 fixed stopcocks
  - ▶ with Quick Lock connections
- Available for:
- ▶ Ø 4.0 mm telescopes 0° or 30°
  - ▶ Ø 2.9 mm telescopes 0° or 30°
  - ▶ Ø 2.0 mm telescopes 0° or 30°

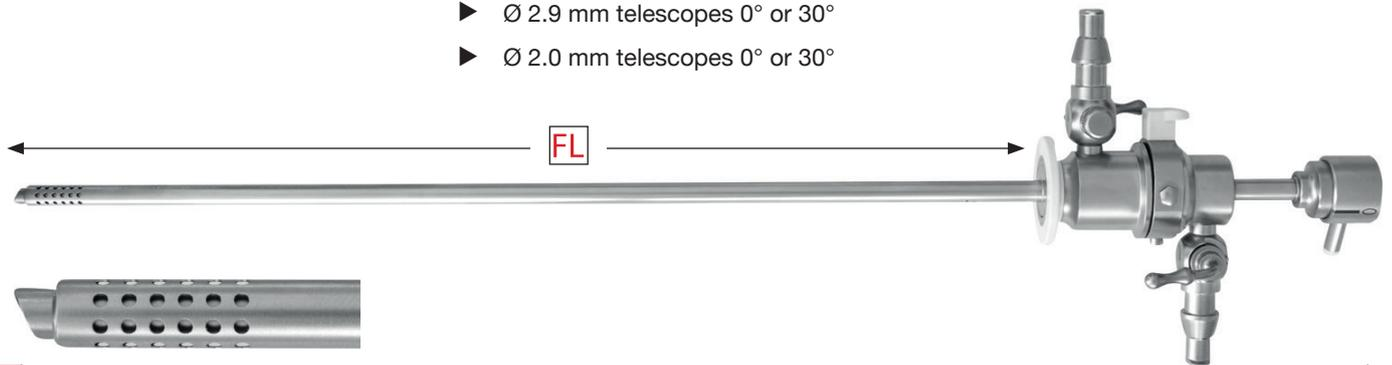

## HYSTEROSCOPY CONTINUOUS FLOW DIAGNOSTIC SHEATH



for Ø 4.0 mm telescopes	FL	Color code	Art. No.	Information
<b>OUTER</b> DIAGNOSTIC SHEATH; Ø 6.5 mm	240 mm	■ blue	640-015-41	
DIAGNOSTIC <b>INNER</b> SHEATH 0°; Ø 5.4 mm	260 mm	■ blue	640-015-42	 601-114-00HD, 601-114-00HD2
DIAGNOSTIC <b>INNER</b> SHEATH 30°; Ø 5.4 mm	260 mm	■ blue	640-015-44	 601-114-30HD, 601-114-30HD2
OBTURATOR		■ blue	640-015-45	 Ø 6.5 mm
<b>for Ø 2.9 mm telescopes</b>				
<b>OUTER</b> DIAGNOSTIC SHEATH; Ø 5.0 mm	243.5 mm	□ white	640-015-31	
DIAGNOSTIC <b>INNER</b> SHEATH 0°; Ø 4.0 mm	260 mm	□ white	640-015-32	 601-103-00HD2
DIAGNOSTIC <b>INNER</b> SHEATH 30°; Ø 4.0 mm	260 mm	□ white	640-015-34	 601-103-30HD2
OBTURATOR		□ white	640-010-35	 Ø 5.0 mm
<b>for Ø 2.0 mm telescopes</b>				
<b>OUTER</b> DIAGNOSTIC SHEATH; Ø 3.7 mm	200 mm	■ red	640-015-21	
DIAGNOSTIC <b>INNER</b> SHEATH 0°; Ø 2.9 mm	218 mm	■ red	640-015-22	 601-112-00
DIAGNOSTIC <b>INNER</b> SHEATH 30°; Ø 2.9 mm	218 mm	■ red	640-015-24	 601-112-30
OBTURATOR		■ red	640-015-25	 Ø 3.7 mm

# HYSTEROSCOPY CONTINUOUS FLOW OPERATING SHEATHS



Hysteroscopy Compact 'HIGH FLOW' Continuous Flow Operating Sheath

- ▶ with working channel 5 Fr.
  - ▶ with Quick Lock connections
- Available for:
- ▶ Ø 2.9 mm telescopes 12° or 30°
  - ▶ Ø 2.0 mm telescopes 30°

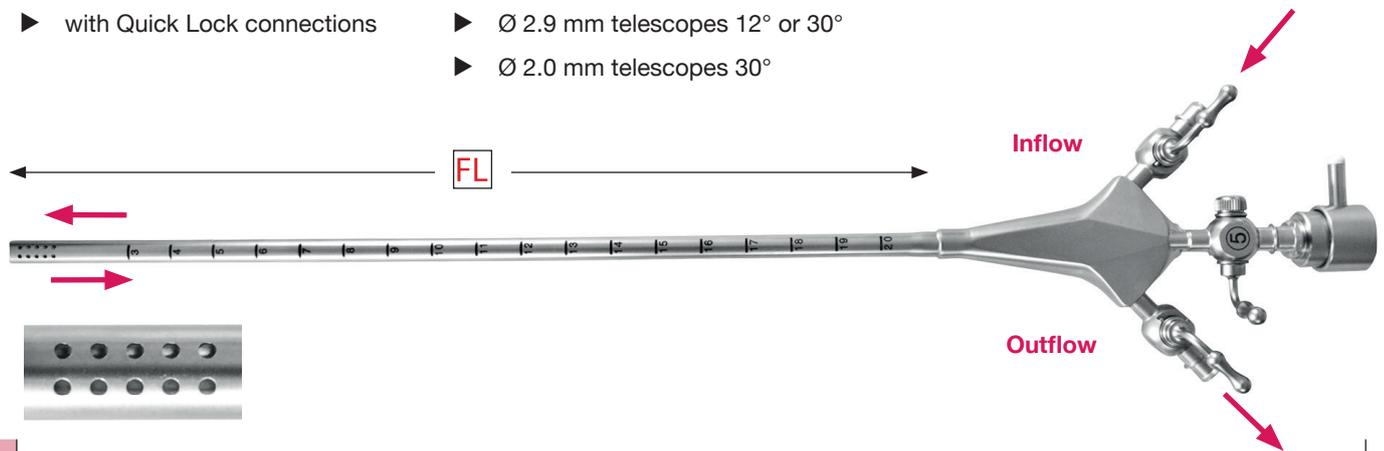

## HYSTEROSCOPY COMPACT 'HIGH FLOW' CONTINUOUS FLOW OPERATING SHEATH



for Ø 2.9 mm telescopes



Ø 5.5 mm; working channel 5 Fr.

**FL 212 mm**

**Information**

**Description**

**Color code**

**Art. No.**

COMPACT OPERATING SHEATH 12° & 30°

□ white

640-022-33

 601-103-12HD2  
 601-103-30HD2



for Ø 2.0 mm telescopes



Ø 4.3 mm; working channel 5 Fr.

**FL 173 mm**

**Information**

COMPACT OPERATING SHEATH 30°

■ red

640-022-43

 601-112-30

for Ø 2.0 mm telescopes



Ø 4.3 mm; working channel 5 Fr.

**FL 215 mm**

**Information**

COMPACT OPERATING SHEATH 30°

■ red

640-022-53

 601-132-30

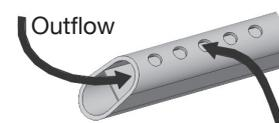
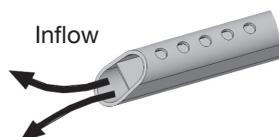

# HYSTEROSCOPY CONTINUOUS FLOW OPERATING SHEATHS



## Hysteroscopy Continuous Flow Operating Sheath 'DROP STYLE'

- ▶ with 2 fixed stopcocks
  - ▶ with Quick Lock connections
- Available for:
- ▶ Ø 4.0 mm telescopes 30° with working channel 5 Fr. & 7 Fr.
  - ▶ Ø 2.9 mm telescopes 30° with working channel 5 Fr.
  - ▶ Ø 2.0 mm telescopes 30° with working channel 5 Fr.



## HYSTEROSCOPY CONTINUOUS FLOW OPERATING SHEATHS 'DROP STYLE'



for Ø 4.0 mm telescopes			
Ø 6.5 mm; working channel 5 Fr.	FL 192 mm		
Description	Color code	Art. No.	Information
OUTER OPERATING SHEATH 30°	■ blue	640-025-41	 601-114-30HD 601-114-30HD2
INNER OPERATING SHEATH 30°	■ blue	640-025-42	
Ø 7.0 mm; working channel 7 Fr.			
OUTER OPERATING SHEATH 30°	■ green	640-025-51	
INNER OPERATING SHEATH 30°	■ green	640-025-52	
for Ø 2.9 mm telescopes			
Ø 5.0 mm; working channel 5 Fr.	FL 192 mm		Information
OUTER OPERATING SHEATH 30°	□ white	640-025-31	 601-103-30HD2
INNER OPERATING SHEATH 30°	□ white	640-025-32	
for Ø 2.0 mm telescopes			
Ø 4.3 mm; working channel 5 Fr.	FL 181 mm		Information
OUTER OPERATING SHEATH 30°	■ red	640-025-21	 601-112-30
INNER OPERATING SHEATH 30°	■ red	640-025-22	

# HYSTEROSCOPY CONTINUOUS FLOW OPERATING SHEATHS



Hysteroscopy Continuous Flow Operating Sheath 'DROP STYLE' with extended function length

- ▶ with 2 fixed stopcocks
  - ▶ with Quick Lock connections
- Available for:
- ▶ Ø 4.0 mm telescopes 30° with working channel 5 Fr.
  - ▶ Ø 2.9 mm telescopes 30° with working channel 5 Fr. & 7 Fr.

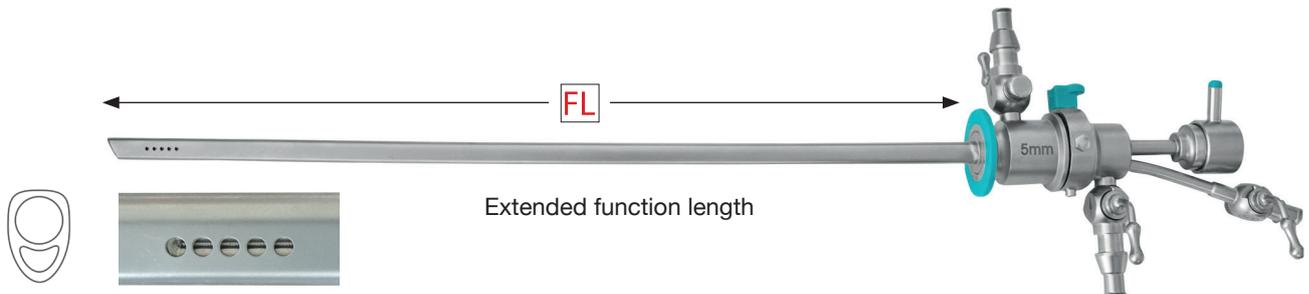

## HYSTEROSCOPY CONTINUOUS FLOW OPERATING SHEATHS 'DROP STYLE'



for Ø 4.0 mm telescopes

Ø 6.5 mm; working channel 5 Fr.

**FL 216 mm**

**Description**

**Color code**

**Art. No.**

**Information**

**OUTER OPERATING SHEATH 30°**

■ blue

640-026-41



**INNER OPERATING SHEATH 30°**

■ blue

640-026-42

601-114-30HD  
601-114-30HD2

for Ø 2.9 mm telescopes

Ø 5.0 mm; working channel 5 Fr.

**FL 216 mm**

**Information**

**OUTER OPERATING SHEATH 30°**

■ turquoise

640-026-31



**INNER OPERATING SHEATH 30°**

■ turquoise

640-026-32

601-103-30HD2

Ø 5.5 mm; working channel 7 Fr.

**FL 216 mm**

**OUTER OPERATING SHEATH 30°**

■ grey

640-026-51

**INNER OPERATING SHEATH 30°**

■ grey

640-026-52



# MICRO INSTRUMENTS FOR HYSTEROSCOPY

- ▶ Semi-rigid & "semi-flex" instruments for instrument channel 5 Fr.
- ▶ Available with LuerLock, or proximal shaft with flexible *anti-kink* protection and *without* LuerLock

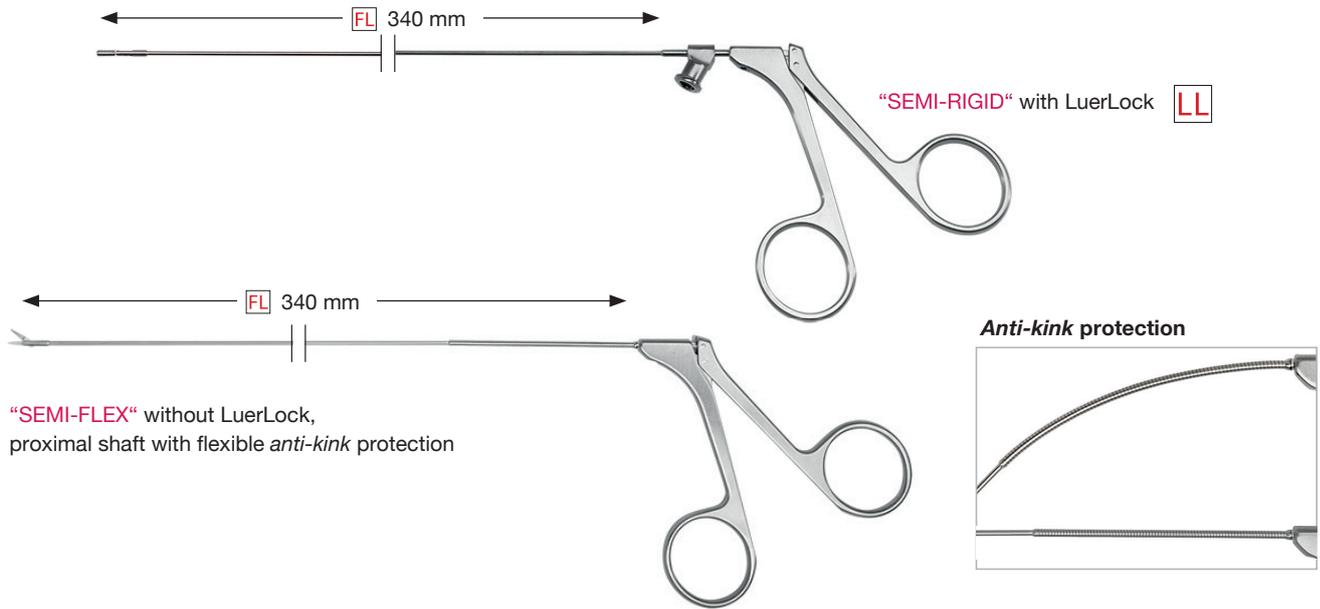

## SEMI-RIGID INSTRUMENTS Ø 1.6 mm; with **LUER LOCK** or **ANTI-KINK** protection

**FL** 340 mm

Description	Standard	Semi-Rigid (LuerLock)	Semi-Flex (Anti-Kink protection)	
BIOPSY FORCEPS ▶ oval ▶ double action	583-214-16	583-214-16LL	-	
SCISSORS ▶ blunt ▶ single action	583-228-16	583-228-16LL	583-228-16FS	
SCISSORS ▶ pointed ▶ single action	583-229-16	583-229-16LL	583-229-16FS	
BIOPSY AND GRASPING FORCEPS ▶ oval ▶ double action	583-256-16	583-256-16LL	583-256-16FS	
PUNCH ▶ through-cutting ▶ single action	583-258-16	583-258-16LL	-	
TENACULUM FORCEPS ▶ oval ▶ double action	583-278-16	583-278-16LL	-	
MYOMA FIXATION instrument	583-280-00	583-280-00	-	

# MICRO INSTRUMENTS FOR HYSTEROSCOPY



► Semi-rigid instruments for instrument channels 5 Fr. or 7 Fr.

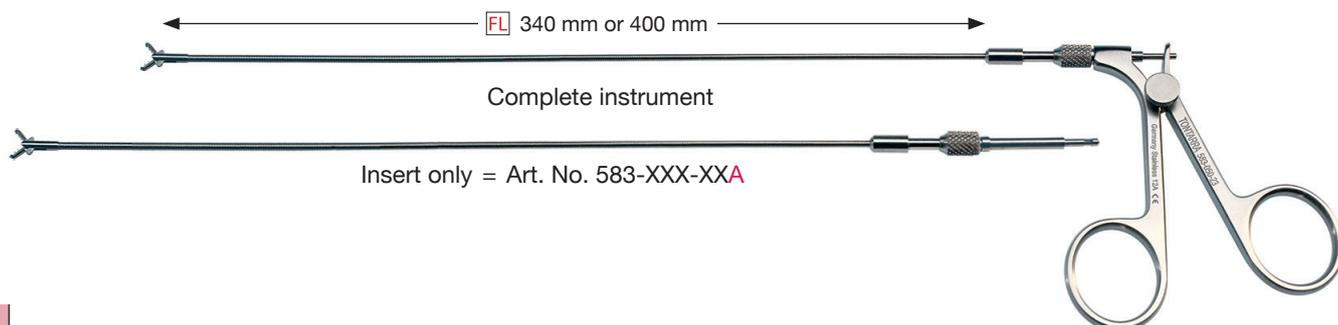

## SEMI-RIGID INSTRUMENTS Ø 1.6 mm; with EXCHANGEABLE INSERTS

FL 400 mm FL 340 mm

Description	Length (FL)	5 Fr.	7 Fr.	Information
BIOPSY FORCEPS	400 mm	583-012-16	583-012-23	 double action
		583-012-16A	583-012-23A	
	340 mm	583-212-16	583-212-23	
		583-212-16A	583-212-23A	
SCISSORS	400 mm	583-022-16	583-022-23	 single action
		583-022-16A	583-022-23A	
	340 mm	583-222-16	583-222-23	
		583-222-16A	583-222-23A	
HOOK SCISSORS	400 mm	-	583-032-23	 single action
		-	583-032-23A	
	340 mm	-	583-232-23	
		-	583-232-23A	
BIOPSY FORCEPS ► oval ► serrated	400 mm	583-052-16	583-052-23	 double action
		583-052-16A	583-052-23A	
	340 mm	583-252-16	583-252-23	
		583-252-16A	583-252-23A	
BIOPSY FORCEPS ► oval ► serrated	400 mm	-	-	 double action
		-	-	
	340 mm	-	-	
		583-256-16A	-	
GRASPING FORCEPS ► alligator jaw	400 mm	583-062-16	583-062-23	 double action
		583-062-16A	583-062-23A	
	340 mm	583-262-16	583-262-23	
		583-262-16A	583-262-23A	
GRASPING FORCEPS ► serrated	400 mm	583-072-16	-	 double action
		583-072-16A	-	
	340 mm	583-272-16	-	
		583-272-16A	-	
HANDLE only (spare part)	583-305-00	for all micro instruments 5/7 Fr. with Art. No's 583-XXX-XX except "semi-rigid instruments with LUERLOCK or ANTIKINK PROTECTION"		

Article numbers ending with **A** = Insert only.



## HF ELECTRODES FOR HYSTEROSCOPY

- ▶ Flexible electrodes for use with **monopolar** current and no-conductive solution (Sorbitol, Mannitol, Glycine); 3-7 Fr.
- ▶ Semi-flexible electrodes for use with **bipolar** current and conductive solution (NaCl 0.9 %); 5 Fr.



### FLEXIBLE ELECTRODES; **MONOPOLAR** FL 470 mm

			
<b>Size</b>	BUTTON ELECTRODE	NEEDLE ELECTRODE, angled	LOOP ELECTRODE
<b>3 Fr.</b>	582-510-03	-	-
<b>5 Fr.</b>	582-510-05	582-511-05	582-514-05
<b>7 Fr.</b>	582-510-07	582-511-07	582-514-07

### HF CONNECTION CABLES; **MONOPOLAR** for working elements and flexible electrodes

Available for following units:	3.0 m	Instrument side	
Erbe/ICC/ACC/Storz Ø 5.0 mm Valleylab, Conmed Ø 8.0 mm TONTARRA mod. PWT-400; Equipment with banana plug Ø 4.0 mm	582-531-02 582-532-03 582-533-04	Round plug 	For further information and pictures see the overview about cables in the chapter "HF Generator & Connection cables".



### SEMI-FLEXIBLE ELECTRODES; **BIPOLAR** FL 360 mm

For use in <b>bipolar</b> current mode and conductive solution (physiologic saline solution, NaCl 0.9 %)			
<b>Size</b>	BUTTON ELECTRODE	NEEDLE ELECTRODE angled	NEEDLE ELECTRODE straight
<b>5 Fr.</b>	582-515-05	582-516-05	582-517-05

### HF CONNECTION CABLES; **BIPOLAR** for semi-flexible electrodes with bipolar cables for flat-cable plug

Available for following units:	3.0 m	5.0 m	Instrument side	
Erbe; Storz/unit side round plug Berchthold/Martin/unit side round plug US-Models; 2-pins/unit side banana plugs TONTARRA mod. PWT-400; Valleylab; International Models; 2 pins	287-200-30 287-205-30 287-210-30 287-215-30	287-200-50 287-205-50 287-210-50 287-215-50	Flat plug 	For further information and pictures see the overview about cables in the chapter "HF Generator & Connection cables".

# HYSTERO-BLOCK

► Pain reduction made easy, safe and reliable.



## PARACERVICAL LOCAL BLOCKADE IN HYSTEROSCOPY (hysteroscopes up to approx. Ø 5.0 mm) & MINI-RESECTOSCOPY

“Applying injection of local anesthetics before hysteroscopic office procedures leads to significant pain reduction”.

*The practical guideline in office hysteroscopy*, by SEGI  
(Società Italiana di Endoscopia Ginecologica)



**With more than 60,000 diagnostic and operative hysteroscopic procedures Dr. Raffaele Ricciardi is one of the top experts in the field.** He also published and co-authored several studies and articles. Dr. Ricciardi annually performs 1300 surgeries, of these over 700 with paracervical local blockades.

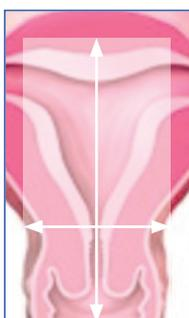

Anesthetized area

Criteria to apply local anesthesia on the patient’s side are anatomic circumstances (for example patients who never gave birth may experience more pain), or the anticipated anxiety and stress level during an intervention; **applying local anesthesia is reassuring for patient and gynecologist alike.**

Another criteria is of course the intervention itself; its duration is a determining factor for pain sensation. In any case: Anesthesia assistance should be within reach in case of an emergency.

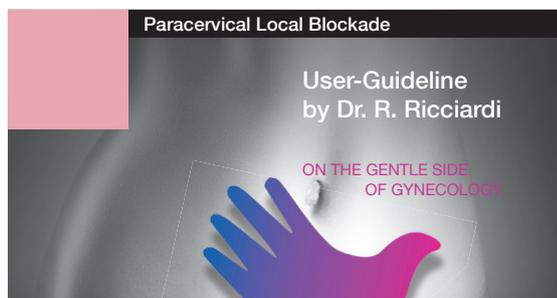

Please contact us for further information and the *User-Guideline* by Dr. Ricciardi.

### Dr. Raffaele RICCIARDI

born in Andria, Italy, in 1953, graduated *cum laude* in Medicine at the University of Pavia in 1977, and received his Certification as a specialist in Obstetrics and Gynecology in 1982.

In 1983 he started his brilliant career as a gynecologist at the renowned IRCCS (Institute for Research and Health Care) polyclinic “Casa Sollievo della Sofferenza”, San Giovanni Rotondo. Since 1985 he dedicated himself intensively to diagnostic and operative hysteroscopy, participating as instructor, lecturer and speaker in several courses, conferences and congresses around the world.

In 1998 he became a member of the Executive Council at the Diagnostic and Operative Hysteroscopy School “Arbor Vitae”, directed by Prof. Ivano Mazzon (based in Rome).

Since 2007 he is the Director of the Hysteroscopy Department, Abano Terme Polyclinic.

Reference center for Mini-Resectoscopy

## HYSTERO-BLOCK

**FL** 270 mm

Description	Art. No.	
HYSTERO-BLOCK NEEDLE ► Ø 20G	BELO/2-PB02N (Box of 10 pcs.)	

Produced by BEL Bio Engineering Laboratories S.R.L, Italy - distributed by TONTARRA

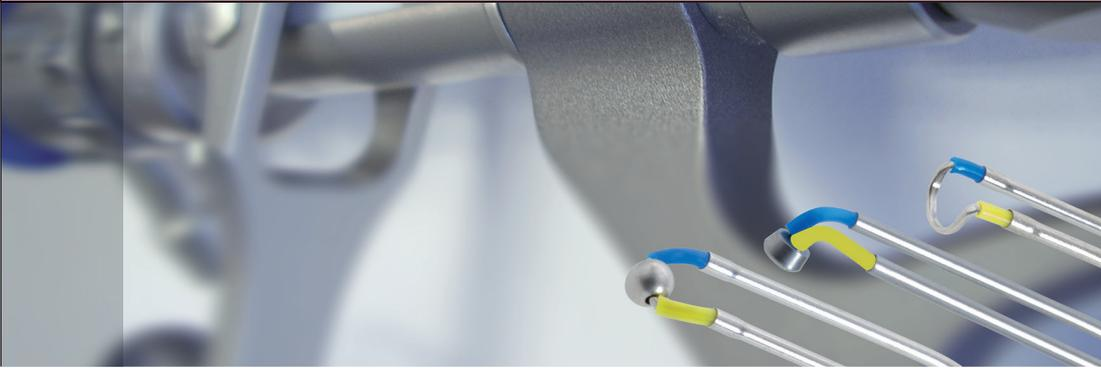

# RESECTOSCOPY

Ø 4.0 mm

◀ 24/26 Fr.

◀ 27/28.5 Fr.

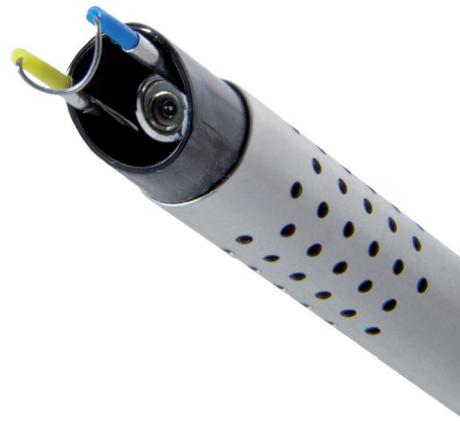



# RESECTOSCOPY

► Schematic overview

HYBRID RESECTOSCOPY

> BOTH SYSTEMS <

RESECTOSCOPY **monopolar**



## HYBRID RESECTOSCOPY

- for **monopolar** use or
- for **bipolar** use in saline solution NaCl 0.9 %

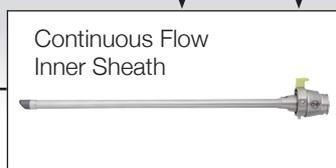
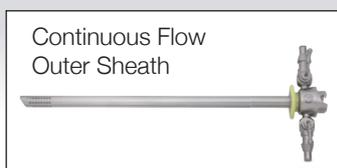

(rotatable or non-rotatable models)

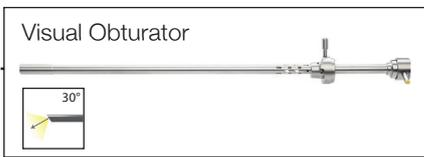
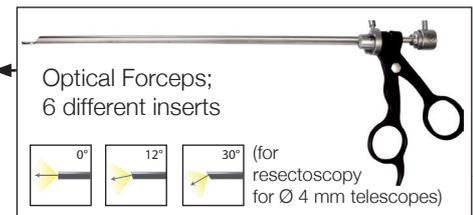

Irrigation & Tubing connectors; sealing caps

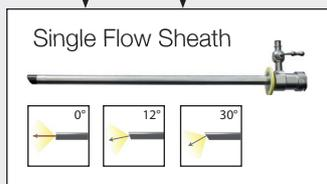

RESECTOSCOPY for **monopolar** use only

- 24/26 Fr.
- 27/28.5 Fr.
- 19/22 Fr.

Systems and components for Ø 4.0 mm telescopes  
 Systems and components for Ø 2.9 mm telescopes

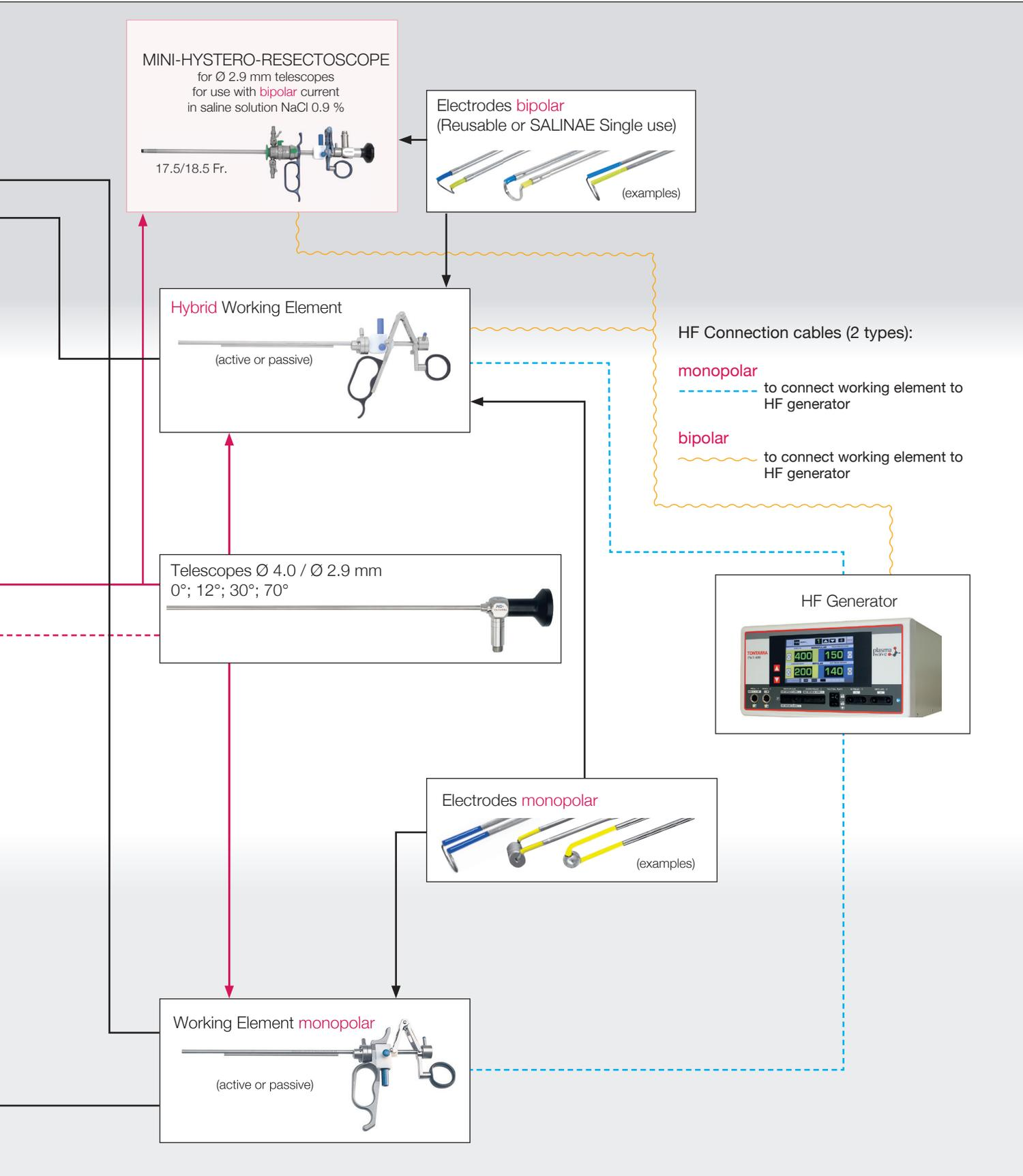



# RESECTOSCOPY

TONTARRA features an extensive resectoscopic modular system build around supreme quality resectoscopic sheaths in different sizes, several types of working elements, plus a wide range of electrodes for use with monopolar current, or bipolar current in saline solution (0.9 % NaCl).

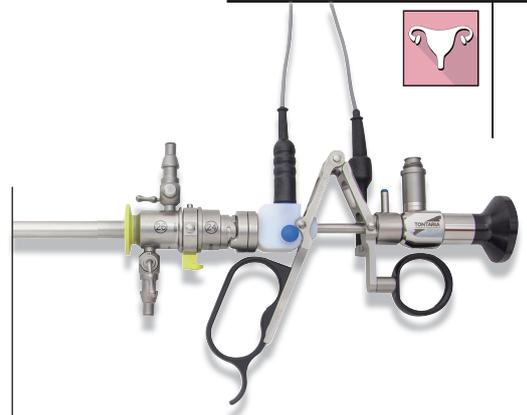

TONTARRA Hybrid Resectoscopy Systems respond to actual trends in contemporary gynecologic resectoscopy.

## TONTARRA'S PORTFOLIO INCLUDES

### FOR Ø 4.0 mm TELESCOPES:

► RESECTOSCOPY LINE 24/26 Fr.

- Continuous flow sheaths for mono- & bipolar use
- Single flow sheaths for monopolar use
- Hybrid Working elements for mono- or bipolar current, or working elements only for monopolar use; working elements for Gyrus electrodes

► RESECTOSCOPY LINE 27/28.5 Fr.

- Continuous flow sheaths for monopolar use
- Single flow sheaths for monopolar use

► COMPATIBLE MICRO TOOLS

- Optical forceps for telescopes Ø 4.0 mm
- Preparation Loops for myomectomy

### FOR Ø 2.9 mm TELESCOPES:

► RESECTOSCOPY LINE 19/22 Fr.

- Continuous flow sheaths for mono- & bipolar use
- Single flow sheaths for monopolar use

► MINI-HYSTERO-RESECTOSCOPE 17.5/18.5 Fr.

- for bipolar use
- with extra working sheath for hysteroscopy

The tendency clearly goes towards the use of bipolar current in saline solution (0.9 % NaCl) as distension medium thanks to its several advantages:

- less risk for hyponatremia and hypervolemia
- less distension volume/less strain on the tissue
- lower work temperature on tissue during surgery which results in less necrosis around the treated areas

- Reusable Mono- & Bipolar electrodes and bipolar **single use** electrodes (Salinæ)

19/22 Fr.    24/26 Fr.    27/28 Fr.

#### Monopolar electrodes



(examples)

#### Bipolar electrodes



#### Preparation loops



(examples)

#### 19/22 Fr: TONTARRA's „White Line“

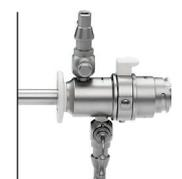

A further miniaturization of instruments in Gynecology is reflected by TONTARRA's 19/22 Fr. resectoscopy system for Ø 2.9 mm telescopes with loops optimally designed for more patient-friendly, lower impact interventions which result in a faster healing process for the patient and cost reduction for health care systems.

# RESECTOSCOPY SYSTEM FOR Ø 4.0 mm TELESCOPES

- ▶ HYBRID HF working elements 24/26 Fr.



■ 24/26 Fr.

Hybrid Resectoscopes facilitate the gradual integration of new procedures into clinics, and provide the freedom of choice to either proceed working with monopolar distension mediums, or to gradually change procedures to the use of bipolar current in saline solution.

A light-weight and extremely ergonomic working element.

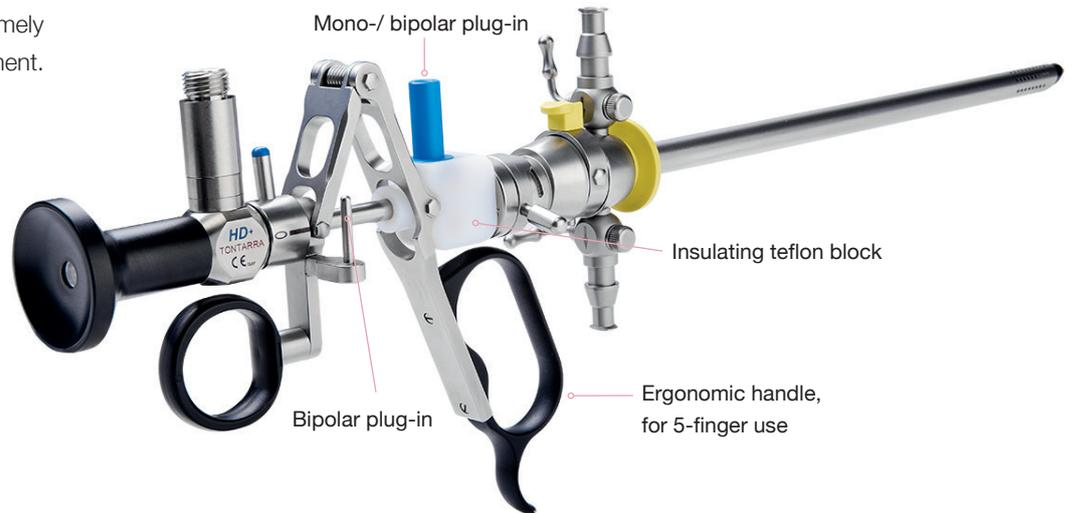

## HYBRID HF WORKING ELEMENTS; closed handle

- ▶ For use with electrodes in **monopolar** current mode and non-conductive solution (e.G. Sorbitol, Mannitol, Glycine)
- ▶ For use with electrodes in **bipolar** current mode and conductive solution (physiologic saline solution, NaCl 0.9 %)

Description	Art. No.	HF-Connection
WORKING ELEMENT; active 	630-235-10B	upwards
WORKING ELEMENT; passive 	630-235-60B	upwards
SAFETY DISTANCE HOLDER for bipolar working element 630-235-10B; 635-235-60B (1.1 mm width) 	582-150-02GUB	-

# RESECTOSCOPY SYSTEM FOR Ø 4.0 mm TELESCOPES



► HYBRID continuous flow sheaths for **mono-** & **bipolar** use

■ 24/26 Fr.

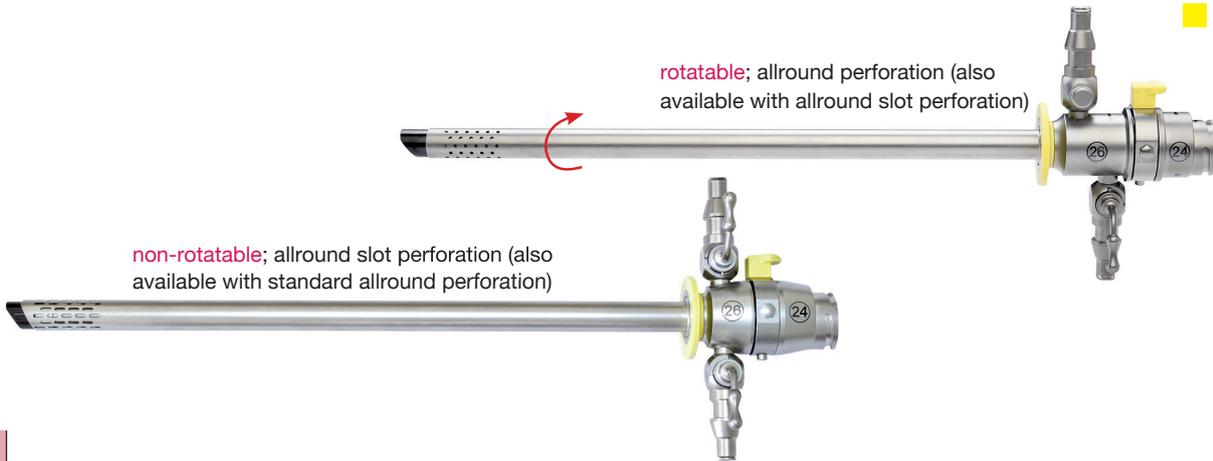

CONTINUOUS FLOW SHEATHS; 2 stopcocks; without obturator

► ■ yellow



Description	Allround perforation	Slot perforation
The continuous flow sheaths are available with allround- or slot perforation (see the pictures to the right)		
<b>non-rotatable</b>		
<b>OUTER SHEATH</b> ► 26 Fr. ► 2 stopcocks		630-204-06
<b>INNER SHEATH</b> ► 24/26 Fr.		630-204-07
<b>rotatable</b>		
<b>OUTER SHEATH</b> ► 26 Fr. ► 2 stopcocks		630-204-26
<b>INNER SHEATH</b> ► 24/26 Fr.		630-209-06
<b>OUTER SHEATH</b> ► 26 Fr. ► 2 stopcocks		630-209-07
<b>INNER SHEATH</b> ► 24/26 Fr.		630-209-26
601-104-00HD; 601-104-00HD2	601-104-12HD; 601-104-12HD2	601-104-30HD; 601-104-30HD2

# RESECTOSCOPY SYSTEM FOR Ø 4.0 mm TELESCOPES

► Obturators & adaptor



■ 24/26 Fr.

## OBTURATORS; ADAPTOR

➔ 24/26 Fr.

Description	■ yellow	Information
STANDARD OBTURATOR 	630-215-24	
DEFLECTING TIP OBTURATOR 	630-220-24	
VISUAL OBTURATOR 	630-225-24	 30° 601-104-30HD 601-104-30HD2
VISUAL OBTURATOR with 1 instrument channel 5 Fr. 	630-230-24	
ADAPTOR for using optical instruments in resectoscopy sheaths 	630-035-25	

For Hybrid Resectoscopy Systems and monopolar single flow sheaths

## MICRO TOOLS COMPATIBLE WITH THE 24/26 FR. & 27/28.5 FR. RESECTOSCOPY SYSTEM

► Optical forceps  
(for further information see page 35)



ADAPTOR for using optical instruments in resectoscopy sheaths

➔ 24/26 Fr. & 27/28.5 Fr.

(Art. No. 630-035-25)

# RESECTOSCOPY SYSTEM FOR Ø 4.0 mm TELESCOPES



- ▶ Reusable electrodes for use with **bipolar** current and conductive solution (NaCl 0.9 %)
- ▶ SALINÆ disposable electrodes for use with **bipolar** current and conductive solution (NaCl 0.9 %)

■ 24/26 Fr.

## BIPOLAR ELECTRODES; reusable or single use

➔ 24/26 Fr.

Description	Color code	Reusable	SALINÆ Single use electrodes*	
LOOP ELECTRODE; angled; 30°	■ yellow/blue	630-240-00B	630-240-00B-S	
PI CUT LOOP ELECTRODE; high temperature resistance and longer use	■ yellow/blue	630-240-00BPI	-	
LOOP ELECTRODE	■ yellow/blue	630-240-05B	-	
LOOP ELECTRODE; straight	■ yellow/blue	630-240-10B	630-240-10B-S	
BALL ELECTRODE; Ø 3 mm	■ yellow/blue	630-240-15B	630-240-15B-S	
BALL ELECTRODE; Ø 5 mm	■ yellow/blue	630-240-20B	-	
ROLLER ELECTRODE; Ø 3 mm	■ yellow/blue	630-240-25B	-	
ROLLER ELECTRODE; Ø 5 mm	■ yellow/blue	630-240-30B	-	
CONICAL ELECTRODE	■ yellow/blue	630-240-35B	-	
KNIFE ELECTRODE	■ yellow/blue	630-240-40B	630-240-40B-S	

\* Sterile, single packaged; 5 pcs./box

For cable connection see cable overview on the next page or in chapter "HF Generator & Connection cables".

# RESECTOSCOPY SYSTEM FOR Ø 4.0 mm TELESCOPES

▶ Reusable electrodes for use with **bipolar** current and conductive solution (NaCl 0.9 %)



■ 24/26 Fr.

## BIPOLAR ELECTRODES; reusable

➡ 24/26 Fr.

Description	Color code	Reusable	SALINÆ Single use electrodes	
VAPORIZATION ELECTRODE; Ø 3 mm; toothed	■ yellow/blue	630-240-45B	–	
VAPORIZATION ELECTRODE; Ø 5 mm; smooth	■ yellow/blue	630-240-60B	–	
BAND ELECTRODE; angled	■ yellow/blue	630-240-65B	–	
BAND ELECTRODE; angled	■ yellow/blue	630-240-70B	–	
VAPORIZATION ELECTRODE; cone shaped	■ yellow/blue	630-240-75B	–	

## HF CONNECTION CABLES; **BIPOLAR** to connect working elements to HF generator; **BIPOLAR** mode for resectoscopy

Available for following units:	Length	Art. No.	
Erbe ICC/ACC, Storz	3.0 m	287-200-30BR	For further information and pictures see the overview about cables in the chapter "HF Generator & Connection cables".
Berchthold/ Martin mod. Maxium	3.0 m	287-205-30BR	
TONTARRA mod. PWT-400; International Models; 2-pins	3.0 m	287-215-30BR	
Erbe mod. VIO 300D and VIO3; Karl Storz mod./ Autocon II 400	4.0 m	287-220-30BR	
Emed-HF mod. Spectrum	4.5 m	287-225-30BR	
Bowa mod.; ARC 350 & 400; Karl Storz mod./ Autocon III 400	4.5 m	287-230-30BR	

# RESECTOSCOPY SYSTEM FOR Ø 4.0 mm TELESCOPES

- ▶ Working elements; **monopolar**
- ▶ Single flow sheaths



- 24/26 Fr.
- 27/28.5 Fr.

## MONOPOLAR HF WORKING ELEMENTS; closed handles

Description	Art. No.	HF-Connection	
WORKING ELEMENT; active	630-235-10	downwards	
WORKING ELEMENT; passive	630-235-60	downwards	
WORKING ELEMENT; active	630-235-11	upwards	
WORKING ELEMENT; passive	630-235-61	upwards	

Can be used with the continuous Flow Sheaths

## SINGLE FLOW SHEATHS; 24 Fr. (**monopolar use recommended**)

Size	Color code	Art. No.	Information
SINGLE FLOW SHEATH with 1 stopcock 	■ yellow	630-200-24	
SINGLE FLOW SHEATH with central valve 		630-202-24	

# RESECTOSCOPY SYSTEM FOR Ø 4.0 mm TELESCOPES

- ▶ Reusable electrodes for use with **monopolar** current and no-conductive solution (Sorbitol, Mannitol, Glycine)



■ 24/26 Fr.

## MONOPOLAR HF ELECTRODES

➡ 24/26 Fr.

➡ 24/26 Fr.	Color code	Art. No.	Electrode Spec.	
LOOP ELECTRODE; angled 30°	■ yellow	630-240-00	30°	
LOOP ELECTRODE; angled 12°	■ blue	630-240-05	-	
LOOP ELECTRODE; straight	■ yellow	630-240-10	-	
BALL ELECTRODE	■ yellow	630-240-15	Ø 3.0 mm	
	■ yellow	630-240-20	Ø 5.0 mm	
ROLLER ELECTRODE	■ yellow	630-240-25	Ø 3.0 mm	
	■ yellow	630-240-30	Ø 5.0 mm	
CONICAL ELECTRODE	■ yellow	630-240-35	-	
KNIFE ELECTRODE; angled	■ yellow	630-240-40	-	
VAPORIZATION ELECTRODE; toothed	■ yellow	630-240-45	Ø 3.0 mm	
	■ yellow	630-240-50	Ø 5.0 mm	
VAPORIZATION ELECTRODE; smooth	■ yellow	630-240-55	Ø 3.0 mm	
	■ yellow	630-240-60	Ø 5.0 mm	
BAND ELECTRODE; angled	■ yellow	630-240-65	30°	
	■ yellow	630-240-70	0°/12°	

For cable overview see Chapter "HF Generator & Connection cables"



24/26 Fr.

## PREPARATION LOOPS

- ▶ » COLD LOOPS « for safe submucosal Myomectomy, or Synechiolysis
- ▶ For submucosal G1 and G2 Myomas



### THE MECHANICAL ENUCLEATION TECHNIQUE / ADVANTAGES OF COLD LOOPS:

- ▶ Less traumatizing intervention: less weakening of the myometrium
- ▶ Avoiding of thermal damage to blood vessels: The vascularised connective tissue bridges are lacerated without the use of any type of HF current
- ▶ No forming of fibrotic scarring during the healing process

### THE METHOD IN SHORT:

Following the elimination of the intracavitary component using the traditional resectoscopic "slicing" technique with a monopolar or bipolar current, the intramural component gets removed by using cold loops by exercising force in the cleavage space between the myoma and the surrounding myometrium to separate the myoma from the uterine wall. Thus, the intramural component of the myoma is transformed into an intracavitary component, which can then be removed using the traditional technique.

## PREPARATION LOOPS (COLD LOOPS)

24/26 Fr.

Description	Art. No.		Information
<ul style="list-style-type: none"> <li>▶ straight</li> <li>▶ with rectangular shape</li> </ul>	630-250-00		»Cold Loops«, so-called because they are used without HF current, only employ mechanical energy for enucleation. <ul style="list-style-type: none"> <li>▶ For currentless use only</li> <li>▶ <b>CAUTION:</b> The PREPARATION LOOPS may never be used when the current is on. Make absolutely sure that the resectoscopes is not connected to any HF-unit when you are using the PREPARATION LOOPS.</li> </ul>
<ul style="list-style-type: none"> <li>▶ straight</li> <li>▶ with round shape</li> </ul>	630-250-05		
<ul style="list-style-type: none"> <li>▶ 90°-right angled</li> <li>▶ pointed</li> </ul>	630-250-10		
<ul style="list-style-type: none"> <li>▶ 45°-angled</li> <li>▶ pointed</li> </ul>	630-250-15		
<ul style="list-style-type: none"> <li>▶ straight</li> <li>▶ pointed</li> </ul>	630-250-20		
<ul style="list-style-type: none"> <li>▶ right angle</li> <li>▶ double pointed</li> </ul>	630-250-25		
<ul style="list-style-type: none"> <li>▶ Recommended for use with TONTARRA Resectoscopes 24/26 Fr. (Art. No. 630-235-60 and 630-235-60B)</li> <li>▶ Sterilizable and reusable; compatible with the following sterilization methods: AUTOCLAVE (Stream), STERIS (Peracetic and Peroxyacetic Acid), STERRAD (Gas Plasma), ETO (Ethylene Oxide)</li> </ul>			

**OPTICAL INSTRUMENTS**

▶ Optical forceps for telescopes Ø 4.0 mm



■ 24/26 Fr.  
■ 27/28.5 Fr.

TONTARRA's optical forceps include scissors, forceps and punches for biopsy, foreign body extraction & resectoscopic tissue removal. Extremely sharp cutting jaws, the stability of the entire instrument and an excellent flow rate enable the surgeon to safely perform mini-operations under vision right under the telescope objective.

FOR USE WITH:

Resectoscopy sheaths  24/26 Fr. & 27/28.5 Fr. (with adaptor)

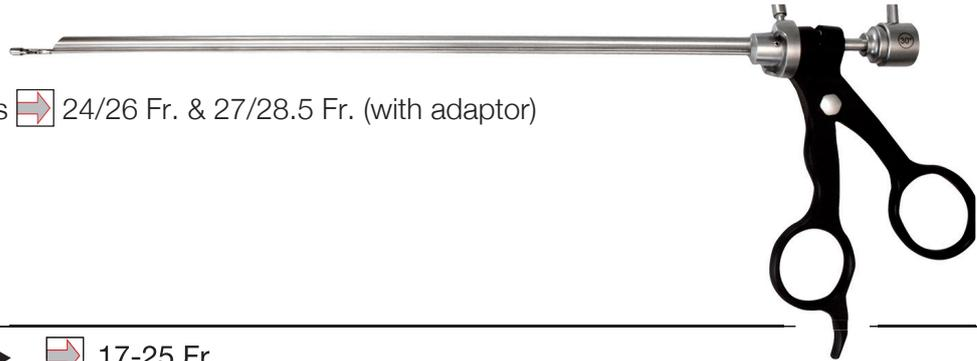

**OPTICAL FORCEPS** ▶  17-25 Fr.

Description	Art. No.		Information
GRASPING FORCEPS ▶ optical 0°/12°/30°	630-035-00		 0° 601-104-00HD 601-104-00HD2
BIOPSY SPOON FORCEPS ▶ optical 0°/12°/30°	630-035-05		 12° 601-104-12HD 601-104-12HD2
BIOPSY PUNCH ▶ optical 0°/12°/30°	630-035-10		 30° 601-104-30HD 601-104-30HD2
HOOK SCISSORS ▶ optical 0°/12°/30°	630-035-20		
BIOPSY SPOON FORCEPS ▶ optical 30°	630-035-13		 30° 601-104-30HD 601-104-30HD2
BIOPSY SPOON FORCEPS ▶ optical 70°	630-035-15		 70° 601-104-70HD 601-104-70HD2
ADAPTOR for using optical instruments in resectoscopy sheaths	630-035-25		

# RESECTOSCOPY SYSTEM FOR Ø 4.0 mm TELESCOPES

- ▶ HYBRID continuous flow sheaths for **mono-** & **bipolar** use
- ▶ Obturators & adaptor



■ 27/28.5 Fr.

## CONTINUOUS FLOW SHEATHS; 2 stopcocks

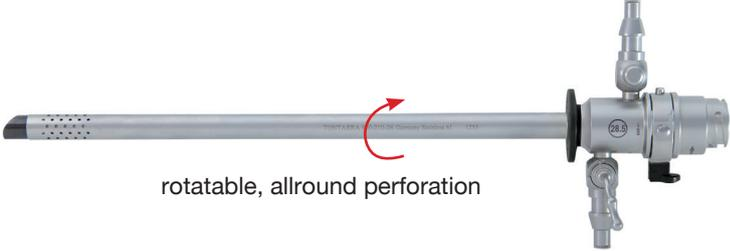

Description	Allround perforation	
  <p>rotatable, allround perforation</p>	 <p>non-rotatable, allround perforation</p>	
	Non-rotatable	Rotatable
OUTER SHEATH (28.5 Fr.)	630-204-08	630-209-08
INNER SHEATH (27 Fr.)	630-204-28	630-209-28

All mono- and bipolar electrodes for the 24/26 Fr. resectoscopy system can be used also with the 27/28.5 Fr. system. For monopolar electrodes 27/28.5 Fr. see next page

## OBTURATORS; ADAPTOR

⇒ 27/28.5 Fr.

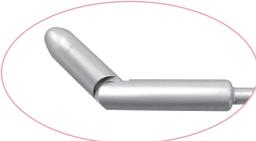
Description	Art. No.	Information
STANDARD OBTURATOR	630-215-27	
DEFLECTING TIP OBTURATOR	630-220-27	
VISUAL OBTURATOR	630-225-27	 30° 601-104-30HD 601-104-30HD2
VISUAL OBTURATOR with 1 instrument channel 7 Fr.	630-230-27	
ADAPTOR for using optical instruments in resectoscopy sheaths	630-035-25	

# RESECTOSCOPY SYSTEM FOR Ø 4.0 mm TELESCOPES



- ▶ Single flow sheaths for **monopolar** use
- ▶ Reusable electrodes for use with **monopolar** current and no-conductive solution (Sorbitol, Mannitol, Glycine)

■ 27/28.5 Fr.

## SINGLE FLOW SHEATHS (**monopolar use recommended**)



Description	Art. No.
SINGLE FLOW SHEATH with 1 stopcock; 27 Fr. 	630-200-27
SINGLE FLOW SHEATH with central valve; 27 Fr. 	630-202-27

## MONOPOLAR ELECTRODES

⇒ 27/28.5 Fr.

⇒ 27/28.5 Fr.	Color code	Art. No.	Electrode Spez.	
LOOP ELECTRODE; angled	■ brown	630-240-01	30°	
	■ brown	630-240-06	12°	
LOOP ELECTRODE; straight	■ brown	630-240-11		
KNIFE ELECTRODE; angled	■ brown	630-240-41		

Monopolar electrodes for 24/26 Fr. resectoscopes can also be used with TONTARRA's 27/28.5 Fr. resectoscopes.

## HF CONNECTION CABLES; **MONOPOLAR** for working elements and flexible electrodes

<b>Available for following units:</b> Erbe/ICC/ACC/Storz Ø 5.0 mm Valleylab, Conmed Ø 8.0 mm TONTARRA mod. PWT-400; Equipment with banana plug Ø 4.0 mm	<b>3.0 m</b> 582-531-02 582-532-03 582-533-04	<b>Instrument side</b> Round plug 	For further information and pictures see the overview about cables in the chapter "HF Generator & Connection cables".
--	--	--	---

## RESECTOSCOPY SYSTEM FOR Ø 4.0 mm TELESCOPES

- ▶ Working elements for Ø 4.0 mm telescopes
- ▶ To use with **bipolar** Gyrus electrodes and Gyros generator  
(from company Olympus/Gyrus)



■ 27/28.5 Fr.

### WORKING ELEMENT TO USE WITH GYRUS ELECTRODES; **BIPOLAR**

- ▶ Titanium; closed handle

Compatibility	Active cutting	Passive cutting	Conus	
GYRUS / Storz	630-350-05	630-350-55	2 included	
extra conus			630-350-90	
GYRUS / Wolf	630-351-05	630-351-55	1 included	
extra conus			630-351-90	
GYRUS / Olympus	630-352-05	630-352-55	1 included	
extra conus			630-352-90	
GYRUS / ACMI		630-353-55	1 included; extra conus not available	



# RESECTOSCOPY

Ø 2.9 mm

◀ 19/22 Fr.

# RESECTOSCOPY SYSTEM FOR Ø 2.9 mm TELESCOPES



- ▶ Working elements (**hybrid** or **monopolar**) for Ø 2.9 mm telescopes

## HYBRID WORKING ELEMENTS; closed handles

- ▶ For use with electrodes in **monopolar** current mode and non-conductive solution (e.G. Sorbitol, Mannitol, Glycine)
- ▶ For use with electrodes in **bipolar** current mode and conductive solution (physiologic saline solution, NaCl 0.9 %)

Description	Art. No.	HF-Connection	
<b>HYBRID</b> WORKING ELEMENT; <b>active</b>	630-335-10B	upwards	
<b>HYBRID</b> WORKING ELEMENT; <b>passive</b>	630-335-60B	upwards	

## WORKING ELEMENTS FOR **MONOPOLAR** USE; closed handles

Description	Art. No.	HF-Connection	
WORKING ELEMENT; <b>active</b>	630-335-10	downwards	
WORKING ELEMENT; <b>passive</b>	630-335-60	downwards	

# RESECTOSCOPY SYSTEM FOR Ø 2.9 mm TELESCOPES

- ▶ Resectoscopy sheaths for **mono & bipolar** use
- ▶ Obturators



19/22 Fr.

## HYBRID CONTINUOUS FLOW SHEATHS; 2 stopcocks

Description	Allround perforation	
 <p>rotatable, allround perforation</p>	 <p>non-rotatable, allround perforation</p>	
	Non-rotatable	Rotatable
OUTER SHEATH; 22 Fr.	630-304-01	630-309-01
INNER SHEATH; 19 Fr.	630-304-21	630-309-21

## SINGLE-FLOW SHEATH (monopolar use recommended)

Description	Color code	Art. No.
 <p>RESECTOSCOPY SHEATH; 19 Fr. 1 stopcock</p>	<input type="checkbox"/> white	630-300-19

## OBTURATORS

19/22 Fr.

Size	Color code	Art. No.	Information
 <p>STANDARD OBTURATOR</p>	<input type="checkbox"/> white	630-315-19	
 <p>VISUAL OBTURATOR</p>	<input type="checkbox"/> white	630-325-19	 601-103-30HD2

## RESECTOSCOPY SYSTEM FOR Ø 2.9 mm TELESCOPES



- ▶ Reusable electrodes for use with **bipolar** current and conductive solution (NaCl 0.9 %)
- ▶ SALINÆ disposable electrodes for use with **bipolar** current and conductive solution (NaCl 0.9 %)  19/22 Fr.
- ▶ Reusable electrodes for use with **monopolar** current and no-conductive solution (Sorbitol, Mannitol, Glycine)

### MONOPOLAR ELECTRODES; reusable BIPOLAR ELECTRODES; reusable & single use

19/22 Fr.

Description	Monopolar	Bipolar	SALINÆ Single use electrodes*	
	<input type="checkbox"/> white	<input type="checkbox"/> white/blue	<input type="checkbox"/> white/blue	
LOOP ELECTRODE; angled; 12°	630-340-00	630-340-00B	630-340-00B-S	
LOOP ELECTRODE; straight; 0°/12°	630-340-05	630-340-05B	630-340-05B-S	
BALL ELECTRODE; Ø 3 mm	630-340-10	630-340-10B	630-340-10B-S	
KNIFE ELECTRODE; angled	630-340-15	630-340-15B	630-340-15B-S	
ROLLER ELECTRODE; Ø 3 mm	630-340-20	-	-	

\*Sterile, single packaged; 5 pcs./box

Example for the bipolar electrode:



630-340-05B or 630-340-05B-S

Reusable and Salinæ single use electrodes for **bipolar** applications come with white/blue insulation.

### HF CONNECTION CABLES; **MONOPOLAR** for working elements and flexible electrodes

Available for following units:	3.0 m	Instrument side	
Erbe/ICC/ACC/Storz Ø 5.0 mm	582-531-02	Round plug	For further information and pictures see the overview about cables in the chapter "HF Generator & Connection cables".
Valleylab, Conmed Ø 8.0 mm	582-532-03		
TONTARRA mod. PWT-400; Equipment with banana plug Ø 4.0 mm	582-533-04		

### HF CONNECTION CABLES; **BIPOLAR** to connect working elements to HF generator; **BIPOLAR** mode for resectoscopy

Available for following units:	Length	Art. No.	
Erbe ICC/ACC, Storz	3.0 m	287-200-30BR	For further information and pictures see the overview about cables in the chapter "HF Generator & Connection cables".
Berchthold/ Martin mod. Maxium	3.0 m	287-205-30BR	
TONTARRA mod. PWT-400; International Models; 2-pins	3.0 m	287-215-30BR	
Erbe mod. VIO 300D and VIO3; Karl Storz/Autocon II 400	4.0 m	287-220-30BR	
Emed-HF mod. Spectrum	4.5 m	287-225-30BR	
Bowa; ARC 350 & 400; Karl Storz mod./ Autocon III 400	4.5 m	287-230-30BR	

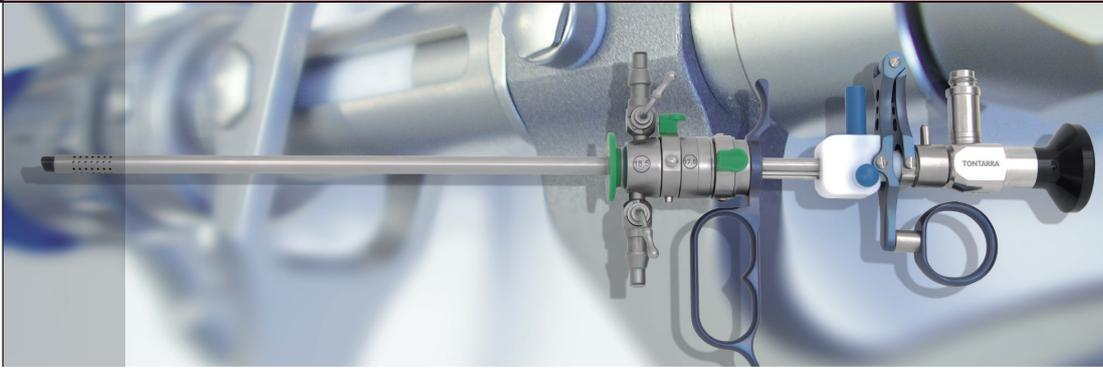

# MINI- HYSTERO-RESECTOSCOPY

Ø 2.9 mm

◀ 17.5/18.5 Fr.

◀ 17 Fr.





# MINI-HYSTERO-RESECTOSCOPY SYSTEM

► Schematic overview

RESECTOSCOPY

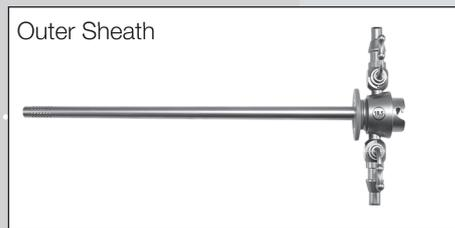
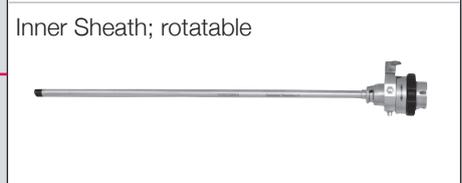
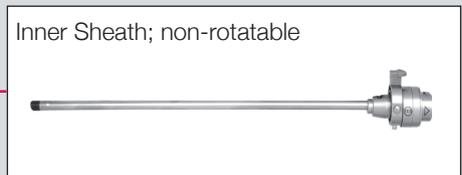
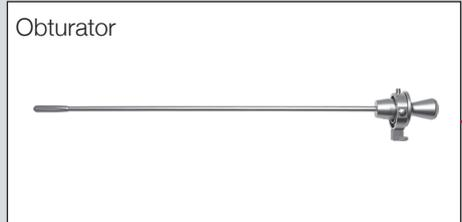

HYSTEROSCOPY



### Hysteroscopy and resectoscopy in one single session:

The one-time placement of the outer sheath allows to change from hysteroscopy to resectoscopy during an intervention. The Quick Lock connecting system enables a smooth exchange of working sheath and inner sheath.



**Small diameter, high functionality:**

The small sizes of sheaths and micro tools reduce tissue damages and the general strain on patients, while the size and form of the specially designed loops still facilitate the treatment also of larger myoma, or extended intracavitary lesions.

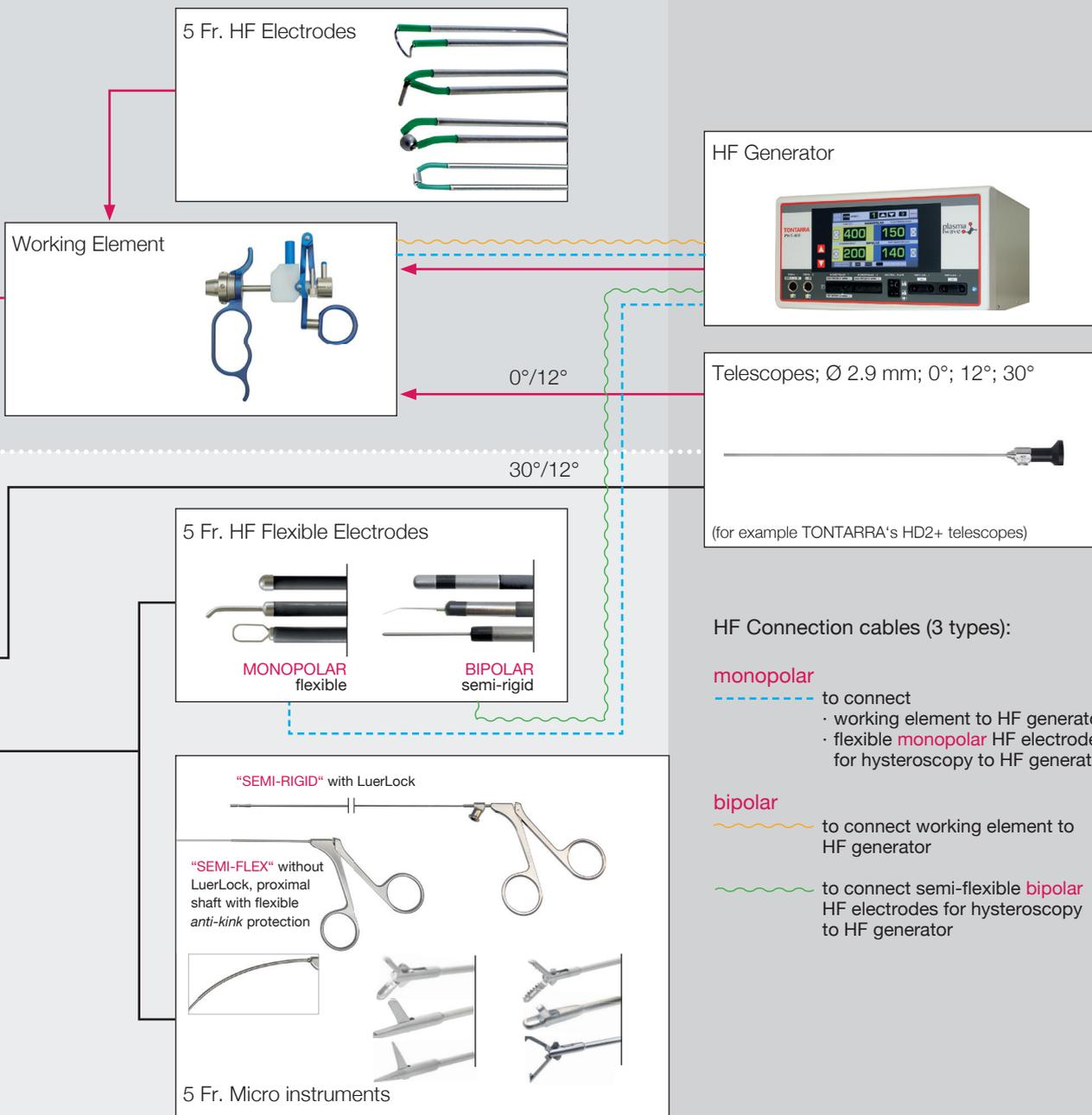

RESECTOSCOPY

HYSTEROSCOPY

# MINI-HYSTERO-RESECTOSCOPY SYSTEM



- ▶ For Ø 2.9 mm telescopes
- ▶ Continuous flow resectoscopy- & working sheaths with 5 Fr. instrument channel; sheaths with allround perforation

■ 17.5/18.5 Fr.

## CONTINUOUS FLOW SHEATHS; WORKING SHEATHS ▶ rotatable or non-rotatable

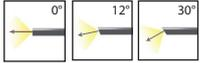
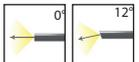
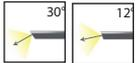
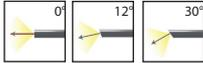
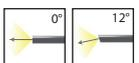
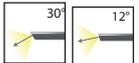

Rotatable	Color code	Art. No.	Information
<b>OUTER SHEATH</b> ▶ 18.5 Fr. 	■ green	582-180-24	
<b>INNER SHEATH</b> ▶ 17.5 Fr. 	■ green	582-180-26	
<b>WORKING SHEATH with instrument channel 5 Fr.</b> ▶ for 18.5 Fr. 	■ green	582-180-39	
Non-rotatable			
<b>OUTER SHEATH</b> ▶ 18.5 Fr. 	■ ■ green/blue	582-180-22	
<b>INNER SHEATH</b> ▶ 17.5 Fr. 	■ green	582-180-21	
<b>WORKING SHEATH with instrument channel 5 Fr.</b> for use with 582-180-22 ▶ for 18.5 Fr. 	■ ■ green/blue	582-180-38	
<b>OBTURATOR for continuous flow sheaths</b> (rotatable & non-rotatable) 	■ green	582-180-23	

## MINI-HYSTERO-RESECTOSCOPY SYSTEM



- ▶ **Bipolar** working elements for Ø 2.9 mm telescopes
- ▶ Reusable electrodes for use with **bipolar** current and conductive solution (NaCl 0.9%)
- ▶ SALINÆ disposable electrodes for use with **bipolar** current and conductive solution (NaCl 0.9 %)

■ 17.5/18.5 Fr.

### BIPOLAR WORKING ELEMENTS; CLOSED HANDLE; HYBRID SYSTEM

- ▶ For use with electrodes in **bipolar** current mode and conductive solution (physiological saline solution, NaCl 0.9 %)



Description	Art. No.	
WORKING ELEMENT; passive	582-180-00B	
SAFETY DISTANCE HOLDER for bipolar working element, Art. No. 582-180-00B	582-150-02GUB (10 pcs. per unit)	

### BIPOLAR HF RESECTOSCOPY ELECTRODES

Description	Color code	Reusable	SALINÆ Single use electrodes*	
HF LOOP ELECTRODE angled 30°	■ green	582-180-40B	582-180-40B-S	
HF LOOP ELECTRODE straight	■ green	582-180-41B	582-180-41B-S	
HF KNIFE ELECTRODE	■ green	582-180-42B	582-180-42B-S	
HF BALL ELECTRODE Ø 2.0 mm	■ green	582-180-43B	582-180-43B-S	
HF ROLLER ELECTRODE Ø 2.0 mm	■ green	582-180-44B	-	

\* sterile, single packaged; 5 pcs./box



## MINI-HYSTERO-RESECTOSCOPY SYSTEM

- ▶ HF connection cables
- ▶ Compatible Micro-tools

HF CONNECTION CABLES; **BIPOLAR** to connect working elements to HF generator; **BIPOLAR** mode for resectoscopy

Available for following units:	Length	Art. No.	
Erbe mod. ICC/ACC; Storz	3.0 m	287-200-30BR	For further information and pictures see the overview about cables in the chapter "HF Generator & Connection cables".
Berchthold/Martin mod. Maxium	3.0 m	287-205-30BR	
TONTARRA mod. PWT-400; International Models; 2-pins	3.0 m	287-215-30BR	
Erbe mod. VIO 300D and VIO3 with multi-contact connector; Karl Storz mod./Autocon II 400	4.0 m	287-220-30BR	
Emed-HF mod. Spectrum	4.5 m	287-225-30BR	
Bowa mod.; ARC 350 & 400 Karl Storz mod./Autocon III 400	4.5 m	287-230-30BR	

## MICRO TOOLS COMPATIBLE WITH THE MINI-HYSTERO-RESECTOSCOPE

Through the outer sheath in combination with the working sheath, tools for hysteroscopy can be applied:

- ▶ 340 / 400 mm semi-rigid instruments (5 Fr. working channels)

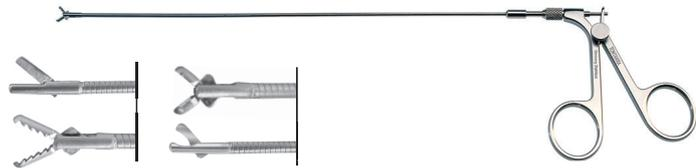

- ▶ 340 mm semi-rigid instruments

"SEMI-FLEX" without LuerLock, proximal shaft with flexible *anti-kink* protection

"SEMI-RIGID" with LuerLock LL



- ▶ Flexible **monopolar** and semi-flexible **bipolar** HF electrodes; 5 Fr.

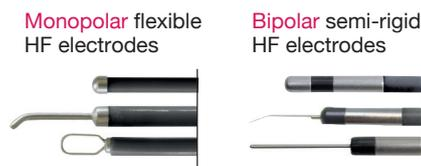

See chapter Hysteroscopy for more details on the micro tools, as well as for cables used with HF electrodes.

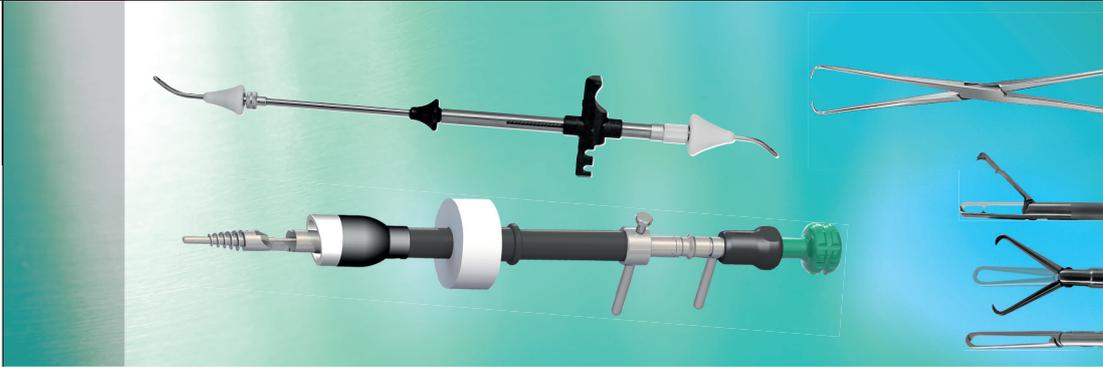

# INSTRUMENTS FOR GYNECOLOGY

Endoscopic Standard Instruments



Laparoscopic Standard Instruments



**INSTRUMENTS FOR GYNECOLOGY**

- ▶ Uterine tenaculum forceps
- ▶ Uterus probes



**UTERINE TENACULUM FORCEPS**

Description		Size	Art. No.
BARRETT uterine tenaculum forceps		18 cm	180-410-18
POZZI uterine tenaculum forceps		26 cm	180-402-26
BRAUN uterine tenaculum forceps		25 cm	180-404-25
SCHACKE uterus manipulator forceps		23 cm	180-494-23

**UTERUS PROBES; Rigid or malleable**

Description	Art. No.	Description	Art. No.
SIMS uterus probe; 32 cm curved up 		SIMSON uterus probe; 32 cm curved down 	
RIGID	180-510-32	RIGID	180-516-32
MALLEABLE	180-511-32	MALLEABLE	180-518-32

## INSTRUMENTS FOR GYNECOLOGY

- ▶ Hegar uterine dilators
- ▶ Intra-uterine probe
- ▶ Portio adapters



### HEGAR UTERINE DILATORS; Available in sets, or single dilators

Description	Specification	Art. No.	
Extra small dilator (not included in a set):	Ø 1.0/2.0 mm	180-354-01	
SET with 8 DILATORS Ø 3.0/4.0 – Ø 17.0/18.0 mm	<b>Set 8 dilators</b>	180-354-98	
	Ø 3.0/4.0 mm	180-354-03	
	Ø 5.0/6.0 mm	180-354-05	
	Ø 7.0/8.0 mm	180-354-07	
	Ø 9.0/10.0 mm	180-354-09	
	Ø 11.0/12.0 mm	180-354-11	
	Ø 13.0/14.0 mm	180-354-13	
	Ø 15.0/16.0 mm	180-354-15	
SET with 12 DILATORS Ø 3.0/4.0 – Ø 25.0/26.0 mm  Content: same as set with 8 DILATORS, plus Ø 19.0/20.0 mm to Ø 25.0/26.0 mm	<b>Set 12 dilators</b>	180-354-99	
	Ø 19.0/20.0 mm	180-354-19	
	Ø 21.0/22.0 mm	180-354-21	
	Ø 23.0/24.0 mm	180-354-23	
	Ø 25.0/26.0 mm	180-354-25	

### COHEN INTRA-UTERINE PROBE

Description			
COHEN INTRA-UTERINE PROBE ▶ Including 2 portio adapters ▶ Firm positioning of the uterus during surgery ▶ Instillation of contrast medium ▶ Adapters optimally seal towards the cervix		PORTIO ADAPTER small	PORTIO ADAPTER large
180-530-00		180-530-01	180-530-02

**INSTRUMENTS FOR GYNECOLOGY**



- ▶ Endospecula
- ▶ Endometrium suction biopsy curettes

**ENDOSPECULA**

▶ Ø 3.0 / 4.0 / 5.0 mm

▶ FL 28.0 cm / 11"

Description		Diameter	Art. No.
KOGAN ENDOSPECULUM ▶ without ratchet		Ø 3.0 mm	180-090-03
		Ø 4.0 mm	180-090-04
		Ø 5.0 mm	180-090-05
KOGAN ENDOSPECULUM ▶ with ratchet		Ø 3.0 mm	180-092-03
		Ø 4.0 mm	180-092-04
		Ø 5.0 mm	180-092-05
KOGAN ENDOSPECULUM ▶ with ratchet ▶ insulated		Ø 3.0 mm	180-093-03
		Ø 4.0 mm	180-093-04
		Ø 5.0 mm	180-093-05

**ENDOMETRIUM SUCTION BIOPSY CURETTES**

▶ Ø 1.0 / 2.0 / 3.0 / 4.0 mm

▶ FL 23.0 cm / 9.2"

Description		Diameter	Art. No.
NOVAK ENDOMETRIUM SUCTION BIOPSY CURETTE		Ø 1.0 mm	180-550-01
		Ø 2.0 mm	180-550-02
		Ø 3.0 mm	180-550-03
		Ø 4.0 mm	180-550-04

# LAPAROSCOPIC INSTRUMENTS FOR GYNECOLOGY



► **solidUterus** – rigid Uterus Manipulator

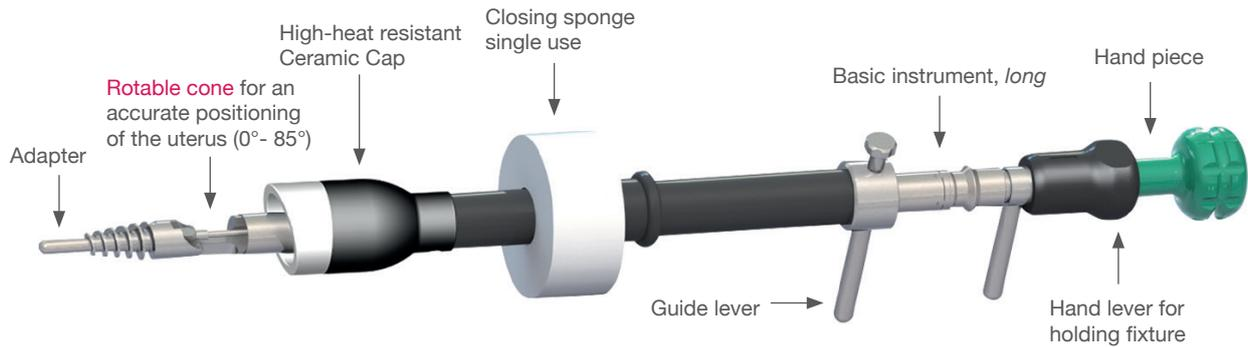

## UTERUS MANIPULATOR ► SET

Description	Art. No	
UTERUS MANIPULATOR SET	587-120-00	
<b>consisting of:</b> ► 1 x basic instrument	587-122-00	
► 1 x counter hold tube	587-122-10	
► 1 x ceramic cap; Ø 36 mm	587-128-02	
► Adapter-Set with 11 tips; 20-120 mm	587-110-00	
► Closing sponge (5 pcs.); sterile; disposable	587-100-50	

## ACCESSORIES / SPARE PARTS

<b>CERAMIC CAP</b> (high-heat resistant; long evity); 1 pc.		<b>POM CAP</b> 1 pc.		<b>PEEK CAP</b> 1 pc.	
Ø 32.0 mm	587-128-01	Ø 32.0 mm	587-148-01		
Ø 36.0 mm	587-128-02	Ø 36.0 mm	587-148-02	25 x 50 mm	587-138-02
Ø 40.0 mm	587-128-03	Ø 40.0 mm	587-148-03	30 x 50 mm	587-138-03
<b>ADAPTER SET WITH 11 TIPS</b> ► 20 - 120 mm				<b>CLOSING SPONGE</b>	
<b>Set complete</b>	587-110-00			5 pcs.; sterile; disposable	587-100-50
20.0 mm	587-110-02	80.0 mm	587-110-08		
30.0 mm	587-110-03	90.0 mm	587-110-09		
40.0 mm	587-110-04	100.0 mm	587-110-10		
50.0 mm	587-110-05	110.0 mm	587-110-11		
60.0 mm	587-110-06	120.0 mm	587-110-12		
70.0 mm	587-110-07				

LAPAROSCOPIC INSTRUMENTS FOR GYNECOLOGY

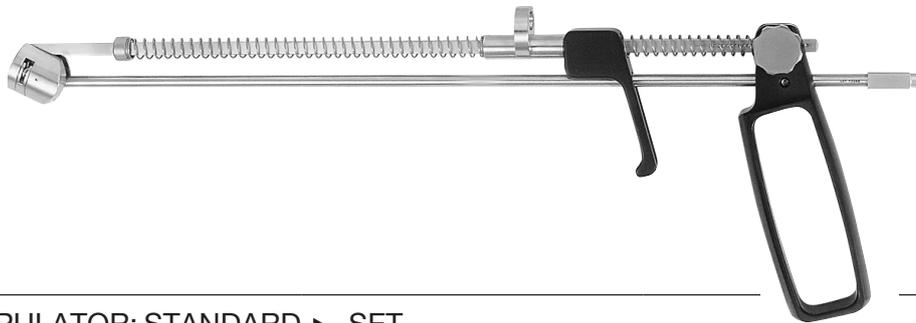

UTERUS MANIPULATOR; STANDARD ► SET

Description	Art. No
UTERUS MANIPULATOR SET (tips can also be ordered separately; Art. No's see below)	587-060-00
<b>consisting of:</b> ► 1 x basic instrument ► 6 x tips	587-060-01
	587-061-08
	587-061-10
	587-063-45
	587-603-55
	587-064-60
587-064-70	
UTERUSMANIPULATOR; without tips	587-060-01

TIPS FOR UTERUS MANIPULATOR

Description	Art. No.	Description	Art. No.
Ø 8.0 mm; 80 mm 	587-061-08	Ø 10.0 mm; 100 mm 	587-061-10
Ø 3.0 mm; 45 mm 	587-063-45	Ø 3.0 mm; 55 mm 	587-063-55
TIP SHORT; with cone; Ø 3.3 mm; 60 mm 	587-064-60	TIP LONG, with cone; Ø 3.3 mm; 70 mm 	587-064-70

LAPAROSCOPIC INSTRUMENTS FOR GYNECOLOGY

► Accessories for morcellation



MYOMA DRILL ► 5.0 / 10.0 mm **FL** 330 / 420 mm

Description	Diameter	FL	Art. No.
MYOMA DRILL 	Ø 10.0 mm	330 mm	587-210-33
		420 mm	587-210-42
	Ø 5.0 mm	330 mm	587-205-32
		420 mm	587-205-42

FORCEPS ► 5.0 / 10.0 mm **FL** 420 mm ► one-piece instruments (non-detachable)

Description	Diameter	FL	Art. No.
TENACULUM-FORCEPS 	Ø 5.0 mm	420 mm	587-220-05
CLAW FORCEPS 	Ø 10.0 mm	420 mm	587-220-10
TENACULUM-FORCEPS 	Ø 10.0 mm	420 mm	587-225-10

LAPAROSCOPIC INSTRUMENTS FOR GYNECOLOGY

▶ Ring Applicators



**RING APPLICATORS**

Description	Art. No.	Information
<p>RING APPLICATOR for TUBE STERILIZATION (reversible)</p> <p>➡ Ø 6.5 mm trocars</p> 	587-230-30	<p>▶ for 2 loops per application</p> <p>▶ simple click mechanism</p>
<p>RING APPLICATOR for OP-LAPARASCOPE</p> <p>➡ Ø 6.0 mm laparoscopes</p> 	587-235-30	<p>▶ for 2 loops per application</p> <p>▶ simple click mechanism</p>
<p>APPLIER</p> 	587-231-65	
<p>INSERT CONE</p> 	587-232-65	

To be used with an operation Laparoscope.



# HF GENERATOR & CONNECTION CABLES



# HF GENERATOR **PLASMA WAVE**

▶ PWT-400



## HF Generator for electrical surgery **PWT-400** **SMART - SAFE - POWERFUL**

Many options – one device.



### SMART

- ▶ Multi disciplinary use
- ▶ Optimized modes for various clinical applications
- ▶ 99 storage positions for application-specific programs/profiles
  - All presets can be adapted individually
  - Customizable program settings and descriptions

### SAFE

- ▶ Self-test during system start and permanent auto check during use
- ▶ Current leakage monitoring
- ▶ Neutral electrode monitoring:
  - use of small neutral electrodes for pediatrics or neonates possible
  - use of split neutral electrodes possible

### POWERFUL

- ▶ Accurate, smooth incisions and effective coagulation due to optimized presets
- ▶ 14 monopolar and bipolar cutting modes and 10 coagulation modes; self-adjusting of output power

### HYBRID RESECTOSCOPY SYSTEMS

- ▶ **A perfect match!** The Plasma Wave HF generator and the TONTARRA bipolar resectoscopy system are perfectly synchronized to each other. Excellent resection effect due to precisely adjusted parameters.

For technical data & more details please ask for our Plasma Wave brochure.



- ▶ Suitable for monopolar and bipolar applications
- ▶ The unit features the simultaneous use of two monopolar handles
- ▶ Compatible with one or two twin foot-switches
- ▶ Intuitive menu navigation via touch display



Twin foot-switch

#### HF connection cables for PWT-400

HF-connection cables **monopolar**

3 m: Art. No. 582-533-04



HF-connection cables **bipolar**, to connect:

- working element to HF generator  
3 m: Art. No. 287-215-30BR

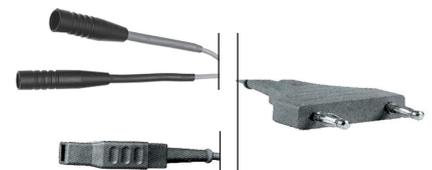

- bipolar electrodes to HF generator  
3 m: Art. No. 287-215-30  
5 m: Art. No. 287-215-50

# HF GENERATOR & HF CONNECTION CABLES

- ▶ HF Unit Plasma Wave PWT 400



## HF UNIT PLASMA WAVE

Description	Art. No.
PWT-400 Plasma Wave; HF generator for electrical surgery  	540-280-50
TWIN FOOT-SWITCH 	540-285-50

## HF CONNECTION CABLES

- ▶ Monopolar HF connection cables

### HF CONNECTION CABLES; **MONOPOLAR**

- ▶ to connect working elements to HF generator; **monopolar** mode for resectoscopy
- ▶ to connect flexible **monopolar** HF electrodes for hysteroscopy to HF generator

Available for following units:	3.0 m	Instrument-side	Unit-side
Erbe/ICC/ACC/Storz; Ø 5.0 mm	582-531-02		
Valleylab; Conmed; Bowa Ø 8.0 mm	582-532-03		
TONTARRA mod. PWT-400; Equipment with banana plug; Ø 4.0 mm	582-533-04		



## HF CONNECTION CABLES

► Bipolar HF connection cables

HF CONNECTION CABLES; **BIPOLAR** ► to connect working element to HF generator;  
**bipolar** mode for resectoscopy

Description	Length	Art. No.	Instrument-side	Unit-side
Erbe mod. ICC/ACC; Storz	3.0 m	287-200-30BR		
Berchthold/Martin mod. Maxium	3.0 m	287-205-30BR		
TONTARRA mod. PWT-400; International Models; 2-pins	3.0 m	287-215-30BR		
Erbe mod. VIO300D; Erbe mod. VIO3; with multi-contact connector; Karl Storz mod. Autocon II 400	3.0 m	287-220-30BR		
Emed-HF mod. Spectrum	4.0 m	287-225-30BR		
Bowa mod. ARC 350 & 400 Karl Storz mod. Autocon III 400	4.5 m	287-230-30BR		

HF CONNECTION CABLES; **BIPOLAR** ► to connect semi-flexible **bipolar** HF electrodes for hysteroscopy to HF generator

Available for following units:	3.0 m	5.0 m	Instrument-side	Unit-side
Erbe; Storz/unit side round plug	287-200-30	287-200-50	 flat plug	
Berchthold/Martin/unit side round plug	287-205-30	287-205-50		
US-Models; 2-pins/unit side banana plugs; Ø 4.0 mm	287-210-30	287-210-50		
TONTARRA mod. PWT-400; Valleylab; International Models; 2 pins; Ø 4.0 mm	287-215-30	287-215-50		



# ACCESSORIES

General Gynecologic Accessories  
Maintenance, Storage & Sterilization



## ACCESSORIES

- ▶ Evacuator; Bladder Syringes; Tubing Connectors & Sealing caps

### ELLIK EVACUATOR & SHEATH CONNECTIONS

Description		Art. No.
ELLIK EVACUATOR without connection; glass Content: Glass 582-400-20; Ball 582-400-25		582-400-05
SHEATH CONNECTION with locking Conus length: 36 mm; Tube length: 115 mm		582-400-10
SHEATH CONNECTION for ELLIK evacuator with connection; <b>Quick Lock</b> Conus length: 36 mm; Tube length: 115 mm		582-400-10QL
SHEATH CONNECTION with cone Conus length: 32.7 mm; Tube length: 115 mm		582-400-15

### BLADDER SYRINGES

Size	With QuickLock 	With sheath connection	Glass cylinder only
			For your convenience we also offer the cylinder as spare part.
50 ml	582-405-05	582-410-05	582-410-05Z
75 ml	582-405-07	582-410-07	582-410-07Z
100 ml	582-405-10	582-410-10	582-410-10Z
150 ml	582-405-15	582-410-15	582-410-15Z

### TUBING CONNECTORS & SEALING CAPS

Description		Art. No.
LuerLock TUBING CONNECTOR		087-940-01
LuerLock TUBING CONNECTOR with STOPCOCK		087-940-02
SEALING CAP for instrument channel with special WATER STOP VALVE; <b>10 pcs. per box</b>	<b>3-10 Fr.</b> 	499-198-00
SEALING CAP for instrument channel <b>10 pc. per box</b>		499-199-00
SHAFT SEALING ADAPTER for use in female urethroscopy		582-090-00



## ACCESSORIES

- ▶ Maintenance; storage & sterilization

### MAINTENANCE; STORAGE & STERILIZATION

Description	Art. No.
<p>TAP &amp; STOPCOCK LUBRICANT;</p> <ul style="list-style-type: none"> <li>▶ special grease for surgical instruments (especially for stopcocks)</li> <li>▶ 5 gram per box</li> </ul>	<p>582-095-00</p>
<p>INSTRUCARE INSTRUMENT OIL SPRAY T3000</p> <ul style="list-style-type: none"> <li>▶ 400 ml</li> </ul>	<p>265-950-40</p>



### PROTECTION

Description	Art. No.
<p>PROTECTING SLEEVE FOR ALL TELESCOPES</p> <ul style="list-style-type: none"> <li>▶ easy handling;</li> <li>▶ up to Ø 5.0 mm</li> <li>▶ reusable</li> <li>▶ Plastic sleeve</li> </ul>	<p>590-000-01 (10 pcs./box)</p>
<p>PROTECTING SLEEVE for ELECTRODES</p> <p>for storage and sterilization for up to 8 electrodes, reusable</p>	<p>590-000-03</p>





**INDEX**

087-940-01	60	287-220-30BR	46	582-405-05	60	583-252-16	18
087-940-02	60	287-220-30BR	58	582-405-07	60	583-252-16A	18
180-090-03	50	287-225-30BR	29	582-405-10	60	583-252-23	18
180-090-04	50	287-225-30BR	40	582-405-15	60	583-252-23A	18
180-090-05	50	287-225-30BR	46	582-410-05	60	583-256-16	17
180-092-03	50	287-225-30BR	58	582-410-05Z	60	583-256-16A	18
180-092-04	50	287-230-30BR	29	582-410-07	60	583-256-16FS	17
180-092-05	50	287-230-30BR	40	582-410-07Z	60	583-256-16LL	17
180-093-03	50	287-230-30BR	46	582-410-10	60	583-258-16	17
180-093-04	50	287-230-30BR	58	582-410-10Z	60	583-258-16LL	17
180-093-05	50	499-198-00	60	582-410-15	60	583-262-16	18
180-354-01	49	499-199-00	60	582-410-15Z	60	583-262-16A	18
180-354-03	49	540-280-50	57	582-510-03	19	583-262-23	18
180-354-05	49	540-285-50	57	582-510-05	19	583-262-23A	18
180-354-07	49	540-803-18	8	582-510-07	19	583-272-16	18
180-354-09	49	540-803-23	8	582-511-05	19	583-272-16A	18
180-354-11	49	540-803-30	8	582-511-07	19	583-278-16	17
180-354-13	49	540-803-50	8	582-514-05	19	583-278-16LL	17
180-354-15	49	540-812-18	8	582-514-07	19	583-280-00	17
180-354-17	49	540-812-23	8	582-515-05	19	583-280-00	17
180-354-19	49	540-812-30	8	582-516-05	19	583-305-00	18
180-354-21	49	540-812-50	8	582-517-05	19	587-060-00	52
180-354-23	49	540-813-18	8	582-531-02	19	587-060-01	52
180-354-25	49	540-813-23	8	582-531-02	35	587-060-01	52
180-354-98	49	540-813-30	8	582-531-02	40	587-061-08	52
180-354-99	49	540-815-18	8	582-531-02	57	587-061-08	52
180-402-26	48	540-815-23	8	582-532-03	19	587-061-10	52
180-404-25	48	540-815-30	8	582-532-03	35	587-061-10	52
180-410-18	48	540-815-50	8	582-532-03	40	587-063-45	52
180-494-23	48	540-822-18	8	582-532-03	57	587-063-45	52
180-510-32	48	540-822-23	8	582-533-04	19	587-063-55	52
180-511-32	48	540-822-30	8	582-533-04	35	587-064-60	52
180-516-32	48	540-822-50	8	582-533-04	40	587-064-60	52
180-518-32	48	540-823-18	8	582-533-04	57	587-064-70	52
180-530-00	49	540-823-23	8	583-012-16	18	587-064-70	52
180-530-01	49	540-823-30	8	583-012-16A	18	587-100-50	51
180-530-02	49	540-823-50	8	583-012-23	18	587-110-00	51
180-550-01	50	540-880-01	8	583-012-23A	18	587-110-02	51
180-550-02	50	540-880-02	8	583-022-16	18	587-110-03	51
180-550-03	50	540-880-04	8	583-022-16A	18	587-110-04	51
180-550-04	50	540-880-05	8	583-022-23	18	587-110-05	51
265-950-40	61	540-880-13	8	583-022-23A	18	587-110-06	51
287-200-30	19	540-890-01	8	583-032-23	18	587-110-07	51
287-200-30	58	540-890-02	8	583-032-23A	18	587-110-08	51
287-200-30BR	29	540-890-04	8	583-052-16	18	587-110-09	51
287-200-30BR	40	540-890-10	8	583-052-16A	18	587-110-10	51
287-200-30BR	46	540-890-14	8	583-052-23	18	587-110-11	51
287-200-30BR	58	582-090-00	60	583-052-23A	18	587-110-12	51
287-200-50	19	582-095-00	61	583-062-16	18	587-120-00	51
287-200-50	58	582-150-02GUB	25	583-062-16A	18	587-122-00	51
287-205-30	19	582-150-02GUB	45	583-062-23	18	587-122-10	51
287-205-30	58	582-180-00B	45	583-062-23A	18	587-128-01	51
287-205-30BR	29	582-180-21	44	583-072-16	18	587-128-02	51
287-205-30BR	40	582-180-22	44	583-072-16A	18	587-128-02	51
287-205-30BR	46	582-180-23	44	583-212-16	18	587-128-03	51
287-205-30BR	58	582-180-24	44	583-212-16A	18	587-138-01	51
287-205-50	19	582-180-26	44	583-212-23	18	587-138-02	51
287-205-50	58	582-180-38	44	583-212-23A	18	587-138-03	51
287-210-30	19	582-180-39	44	583-214-16	17	587-148-01	51
287-210-30	58	582-180-40B	45	583-214-16LL	17	587-148-02	51
287-210-50	19	582-180-40B-S	45	583-222-16	18	587-148-03	51
287-210-50	58	582-180-41B	45	583-222-16A	18	587-205-32	53
287-215-30	19	582-180-41B-S	45	583-222-23	18	587-205-42	53
287-215-30	58	582-180-42B	45	583-222-23A	18	587-210-33	53
287-215-30BR	29	582-180-42B-S	45	583-228-16	17	587-210-42	53
287-215-30BR	40	582-180-43B	45	583-228-16FS	17	587-220-05	53
287-215-30BR	46	582-180-43B-S	45	583-228-16LL	17	587-220-10	53
287-215-30BR	58	582-180-44B	45	583-229-16	17	587-225-10	53
287-215-50	19	582-400-05	60	583-229-16FS	17	587-230-30	54
287-215-50	58	582-400-10	60	583-229-16LL	17	587-231-65	54
287-220-30BR	29	582-400-10QL	60	583-232-23	18	587-232-65	54
287-220-30BR	40	582-400-15	60	583-232-23A	18	587-235-30	54



**INDEX**

587-603-55	52	630-209-07	26	630-240-50	31	630-352-90	36
590-000-01	61	630-209-08	34	630-240-55	31	630-353-55	36
590-000-03	61	630-209-26	26	630-240-60	31	640-010-20	12
601-102-00	7	630-209-28	34	630-240-60B	29	640-010-23	12
601-102-30	7	630-215-24	27	630-240-65	31	640-010-25	12
601-103-00HD2	7	630-215-27	34	630-240-65B	29	640-010-27	12
601-103-12HD2	7	630-220-24	27	630-240-70	31	640-010-30	12
601-103-30HD2	7	630-220-27	34	630-240-70B	29	640-010-33	12
601-104-00HD	6	630-225-24	27	630-240-75B	29	640-010-35	12
601-104-00HD2	6	630-225-27	34	630-250-00	32	640-010-35	13
601-104-12HD	6	630-230-24	27	630-250-05	32	640-010-40	12
601-104-12HD2	6	630-230-27	34	630-250-10	32	640-010-43	12
601-104-30HD	6	630-235-10	30	630-250-15	32	640-010-45	12
601-104-30HD2	6	630-235-10B	25	630-250-20	32	640-015-21	13
601-104-70HD	6	630-235-11	30	630-250-25	32	640-015-22	13
601-104-70HD2	6	630-235-60	30	630-300-19	39	640-015-24	13
601-112-00	7	630-235-60B	25	630-304-01	39	640-015-25	13
601-112-30	7	630-235-61	30	630-304-21	39	640-015-31	13
601-114-00HD	6	630-240-00	31	630-309-01	39	640-015-32	13
601-114-00HD2	6	630-240-00B	28	630-309-21	39	640-015-34	13
601-114-12HD	6	630-240-00BPI	28	630-315-19	39	640-015-41	13
601-114-12HD2	6	630-240-00B-S	28	630-325-19	39	640-015-42	13
601-114-30HD	6	630-240-01	35	630-335-10	38	640-015-44	13
601-114-30HD2	6	630-240-05	31	630-335-10B	38	640-015-45	13
601-114-70HD	6	630-240-05B	28	630-335-60	38	640-022-33	14
601-114-70HD2	6	630-240-06	35	630-335-60B	38	640-022-43	14
601-132-00	7	630-240-10	31	630-340-00	40	640-022-53	14
601-132-30	7	630-240-10B	28	630-340-00B	40	640-025-21	15
630-035-00	33	630-240-10B-S	28	630-340-00B-S	40	640-025-22	15
630-035-05	33	630-240-11	35	630-340-05	40	640-025-31	15
630-035-10	33	630-240-15	31	630-340-05B	40	640-025-32	15
630-035-13	33	630-240-15B	28	630-340-05B-S	40	640-025-41	15
630-035-15	33	630-240-15B-S	28	630-340-10	40	640-025-42	15
630-035-20	33	630-240-20	31	630-340-10B	40	640-025-51	15
630-035-25	27	630-240-20B	28	630-340-10B-S	40	640-025-52	15
630-035-25	33	630-240-25	31	630-340-15	40	640-026-31	16
630-035-25	34	630-240-25B	28	630-340-15B	40	640-026-32	16
630-200-24	30	630-240-30	31	630-340-15B-S	40	640-026-41	16
630-200-27	35	630-240-30B	28	630-340-20	40	640-026-42	16
630-202-24	30	630-240-35	31	630-350-05	36	640-026-51	16
630-202-27	35	630-240-35B	28	630-350-55	36	640-026-52	16
630-204-06	26	630-240-40	31	630-350-90	36	BELO/2-PB02N	20
630-204-07	26	630-240-40B	28	630-351-05	36		
630-204-08	34	630-240-40B-S	28	630-351-55	36		
630-204-26	26	630-240-41	35	630-351-90	36		
630-204-28	34	630-240-45	31	630-352-05	36		
630-209-06	26	630-240-45B	29	630-352-55	36		



· WORLD WIDE DISTRIBUTION NETWORK ·



**TONTARRA Medizintechnik GmbH**  
Daimlerstr. 15 · 78573 Wurmlingen/Germany  
Tel: +49(0) 74 61/9 65 76 -0  
Fax: +49(0) 74 61/9 65 76 -26  
info@tontarra.de

[www.tontarra.de](http://www.tontarra.de)

All rights are reserved. Technical alterations are possible. This folder may be used for no other purpose than offering, buying and selling of our products. No part may be copied or reproduced in any form. In the case of misuse, we retain the rights to recall our catalogs and pricelists and to take legal actions.  
999-350-02E · 01.2019