

SOLUZIONI CONDIVISE PER LA VITA



Informazioni rivolte esclusivamente agli operatori sanitari
Information intended only for healthcare professionals

CUSTOM PACK

MEDICAL



 SVAS BIOSANA SpA



SVAS BIOSANA SpA

Svas Biosana S.p.A. è una realtà costantemente impegnata nell'offrire soluzioni efficaci ed innovative alle **nessità di pazienti e operatori del comparto sanitario**.

Una politica aziendale, fondata su **principi di condivisione delle conoscenze e rafforzamento delle competenze**, assicura che **ricerca, produzione e commercializzazione** forniscano una risposta rapida ed adeguata alle richieste del mercato.



Svas Biosana S.p.A. nasce nel 1972 come impresa commerciale, specializzata nella distribuzione di dispositivi medici. Grazie all'impegno del suo Management, l'azienda cresce progressivamente e in pochi anni diventa un importante punto di riferimento in Italia e all'Estero per il settore sanitario. Col tempo, la società sviluppa un progetto "industriale", acquisendo le competenze tecniche necessarie per realizzare prodotti a marchio proprio. Tale progetto si concretizza con la graduale creazione di divisioni industriali impegnate in diverse linee di prodotti. Nell'anno 2002 la **Svas Biosana** avvia un Laboratorio Chimico di "Ricerca & Sviluppo", in cui un efficiente team di professionisti svolge attività di studio, caratterizzazione e sperimentazione di nuovi materiali e prodotti. Oggi la società opera nel settore della produzione e commercializzazione dei dispositivi medici, attrezzature medicali e prodotti farmaceutici, ponendosi quale interlocutore qualificato per le società clienti nei mercati serviti della Sanità pubblica e privata, GDO, Rivenditori, Aziende terze e Export.

Attualmente il gruppo **Svas Biosana S.p.A.** è formato da cinque società:

- SVAS BIOSANA S.p.A.
- INDUSTRIA FARMACEUTICA GALENICA SENESE S.r.l.
- E.MEDICAL S.r.l.
- HC PHARMA S r l

La **Svas Biosana S.p.A.** vanta, oggi, un consolidato Sistema di Gestione della Qualità, conforme alle norme ISO 9001 e 13485, e una struttura multi-divisionale che consente di esaltare il livello di specializzazione delle singole aree operative:

- Svas
- Farmex
- Medical

SHARED SOLUTIONS FOR LIFE

Svas Biosana S.p.A. is a reality constantly committed to providing effective and innovative solutions to the needs of patients and the healthcare sector professionals. A corporate policy, founded on the principles of knowledge sharing and strengthening of skills, ensures that research, production and marketing provide a quick and appropriate response to market demands.



Svas Biosana S.p.A. was founded in 1972 as a trading company specializing in the distribution of medical devices. Thanks to the commitment of its Management, the company grew steadily and soon became an important point of reference in Italy and abroad for the healthcare industry. Over time, the company develops an "industrial" project, acquiring the technical skills required to manufacture products under its own brand. This project has materialized with the creation of industrial divisions engaged in different lines of products. In 2002, Svas Biosana started a "Research & Development" Chemical-Microbiological Laboratory, in which an efficient team of professionals carries out activities of studying, characterization and testing of new materials and products. Today the Company operates in the production and marketing of medical devices, medical equipment, pharmaceuticals, acting as a qualified partner for Customers companies in the served markets such as public and private Health, Large-Scale Distribution, Retailers, Export and other Companies.

Svas Biosana S.p.A. boasts, today, an established Quality Management System compliant with ISO 9001 and 13485, and a multi-divisional structure, designed to enhance the level of specialization of the individual areas:

- Svas Division
- Farmex Division
- Medical Division

Currently the group Svas Biosana S.p.A. consists of five companies:

- SVAS BIOSANA S.p.A.
- PHARMACEUTICAL INDUSTRY GALENICA SENESE S.r.l.
- E.MEDICAL S.r.l.
- HC PHARMA S.r.l.
- BIOTECH S.r.l.



medical devices, custom pack

MEDICAL



Medical nasce nel 1998 e si occupa dello sviluppo e della produzione di Dispositivi Medici.

Efficienza operativa, competenza tecnica, impegno, nella ricerca forniscono una risposta adeguata alle richieste del mercato.

Medical was established in 1998 and it deals with the development and production of Medical Devices.

Operational efficiency, technical expertise and commitment to research provide an adequate response to market demands.



CUSTOM
PACK



MEDICAL
DEVICES



MEDICAL
DRAPES



Medical è specializzata nella produzione di medicazioni avanzate non aderenti e gel lubrificanti.

Medical is specialized in the production of non-adherent advanced dressings and lubricating gel.

attiva[®]
Plus

Medicazione Sterile non Aderente a base di Centella Asiatica e Urtica Dioica. Favorisce un'accelerazione del processo fisiologico di riparazione tissutale

Non-Adherent Sterile Dressing made with Centella asiatica and Urtica Dioica. It Favors an acceleration of the physiological process of tissue repair

attiva[®]
Gras

Medicazione sterile, non aderente a base di paraffina. Lenisce e protegge le ferite .

Non-Adherent Sterile Dressing made with paraffin. It soothes and protects the wound

farmagel[®]

Dispositivo medico idoneo in tutte le applicazioni medico-diagnostiche dove è necessaria la riduzione dell'attrito tra le superfici a contatto, facilitandone lo scorrimento.

Medical device suitable in all medical-diagnostic applications where it is necessary to reduce friction between the surfaces in contact, facilitating the sliding.

GARANZIA DI QUALITÀ QUALITY ASSURANCE

Istituto Nazionale di Sanità

Approvazione del Sistema di Garanzia della Qualità della Produzione di Farmaci a Strada

SVAS BIOSANA S.p.A. - Divisione MEDICAL

CE 0432

SVAS BIOSANA S.p.A. - Divisione MEDICAL

CE 0432

ITALCERT

CERTIFICATO N° 121-02-01-08

ITALCERT

SVAS BIOSANA S.p.A.

CE 0432

ITALCERT

CERTIFICATO N° 150-04-01-03

ITALCERT

SVAS BIOSANA S.p.A.

CE 0432

ITALCERT

CERTIFICATO N° 442-0M69

SVAS BIOSANA S.p.A. - Divisione MEDICAL

CE 0432

ITALCERT

CERTIFICATO N° 442-SGQ03

SVAS BIOSANA S.p.A. - Divisione MEDICAL

CE 0432

▶ INDICE

INDEX

LINEA TELERIA
MEDICAL DRAPES 11

CARDIOCHIRURGIA VASCOLARE
CARDIO VASCULAR 17

GINECOLOGIA
GYNAECOLOGY 25

CHIRURGIA UROLOGICA
UROLOGY 29

CHIRURGIA ORTOPEDICA
ORTHOPEDIC 33

CHIRURGIA GENERALE
GENERAL SURGERY 37

STUMENTARIO CHIRURGICO
SURGICAL INSTRUMENTS 43

SIRINGHE E AGHI
SIRINGES AND NEEDLES 49

GARZE E MEDICAZIONI
DRESSING 55

CIOTOLE E VASSOI
BOWLS AND TRAYS 59

ACCESSORI PER CAMPO OPERATORIO
ACCESSORIES 63

DISPOSITIVI DI PROTEZIONE DALLE RADIAZIONI
RADIATION PROTECTION DEVICES 69





LINEA TELERIA
MEDICAL DRAPES

Teli TNT
TNT Drapes

p. 12

Camice Standard
Standard Gown

p. 14

Teli Dexter
Dexter Drapes

p. 13

Camice Alta Protezione **p. 15**
High Protection Gown

Teli Microfibra SMS
SMS Drapes

p. 13



LINEA TELERIA
MEDICAL DRAPES



TNT BIACCOPPOATO

Materiale a due strati con una parte assorbentecombinata ad un film di polietilene. L'unione deidue strati avviene attraverso il processo di meltingmentre il suo film crea una barriera totale al passaggio di liquidi e batteri. Questo tipo di materiale è impiegato per la copertura disuperficie e teleria paziente.

BILAMINATE

Material with a two-layer absorber combined with a polyethylene film. The union of the two layers is through the process of melting while his film creates a total barrier to the passage of fluids and bacteria. This type of material is used to cover the surface and drapes patients.



TNT TRIACCOPPIATO

Composto da TNT bianco, che garantisce ottimo comfort al paziente, da un film barriera azzurro, specifico per uso medicale, e da TNT azzurro a base di viscosa con elevate performances di assorbimento sia in termini quantitativi sia di velocità. La morbida struttura del materiale e lo strato "lato paziente" lo rende particolarmente adatto alla realizzazione di campi operatori complessi e ad interventi di lunga durata.

3-LAYER DRAPE

It is composed of a white non-woven fabric, which ensures excellent comfort for the patient, of a blue barrier film, specific for medical use, and of a blue non-woven fabric, made of viscose, with high performances of absorption, both in quantitative terms, both of speed. The soft structure of the material and the "patient side" layer makes it particularly suitable for the realization of complex operating fields and for long duration interventions.



TNT LAMINATO

Si tratta di un materiale di rinforzo largamente apprezzato per le caratteristiche di assorbimento, aspetto visivo e funzionalità. Combina l'elevata capacità di assorbimento dello strato centrale in cellulosa con le caratteristiche del TNT azzurro a base di viscosa, utilizzato come strato superiore. Per le sue caratteristiche di elevata assorbenza è adatto alla realizzazione di campi operatori complessi e ad interventi di lunga durata.

LAMINATED DRAPE

It is a reinforcing material widely appreciated for the absorption characteristics, visual appearance and functionality. It combines the high absorption capacity of the cellulose central layer with the characteristics of blue non-woven fabric, made of viscose, used as a top layer. For its characteristics of high absorbency, it is suitable for the realization of complex operating fields and for long duration interventions.





LINEA TELERIA | MEDICAL DRAPES

DEXTER

Materiale idrorepellente che garantisce una barriera assoluta ai liquidi organici costituendo un reale ostacolo al passaggio di batteri e materiale contaminante ogni genere. Grazie ad un processo di lavorazione specifico, il materiale si presenta molto soffice e con un alto grado di drappeggiabilità. La struttura irregolare delle fibre permette una elevata traspirabilità che distingue questo tessuto da tutti gli altri TNT disponibili. Date queste caratteristiche il materiale è in particolar modo indicato per la realizzazione di camici per operatore e teleria paziente, unendo comfort e protezione.

DEXTER

Hydrophobic material that provides an absolute barrier to body fluids constitute a real obstacle to the passage of bacteria and all kinds of material contamination. Through a specific process, the material is very soft and with a high degree of draping. The irregular structure of the fiber allows a high permeability that distinguishes this tissue from all other available TNT. Given these characteristics, the material is especially suitable for the realization of overalls for operator and patient drapes, combining comfort and protection.



MICROFIBRA SMS

Materiale idrorepellente con una struttura delle fibre a nido d'api, che garantisce una totale barriera al passaggio di liquidi e batteri. Grazie alla sua struttura il tessuto è molto resistente, mantenendo comunque una ottima drappeggiabilità ed un peso specifico estremamente basso. Per queste sue caratteristiche, il microfibra SMS viene impiegato per la produzione di camici chirurgici di alta qualità.

SMS

Waterproof material with a fiber structure honeycomb, which provides a total barrier to the passage of fluids and bacteria. Thanks to its fabric is very durable, while maintaining an excellent draping and a specific gravity very low. To these characteristics, the micro sms is used for surgical gowns production of high quality.





LINEA TELERIA | MEDICAL DRAPES

CAMICE CHIRURGICO STANDARD STANDARD SURGICAL GOWN

4SVAS021502S	M
4SVAS021512S	L
4SVAS021522S	XL
4SVAS021752S	XXL



Camice chirurgico specialistico in TNT idrorepellente SMS gr/mq 50 con polsini in maglina da cm 8 e doppia cucitura, girocollo con fettucce in cotone 100%, chiusura al collo regolabile con velcro, 4 cinture in vita per chiusura interna/ esterna sovrapposta con cartoncino fermacintura.

This surgical specialist gown is made of water-repellent no-woven (weight 50 g / m²), with cotton cuffs 8 cm; with double-stitched; with 100% cotton loops for crew neck; with velcro closure neck adjustable; 4 belts at the waistline for internal / external closure.



LINEA TELERIA | MEDICAL DRAPES

CAMICE CHIRURGO ALTA PROTEZIONE HIGH PROTECTION SURGICAL GOWN

4SVAS022502S
4SVAS022512S
4SVAS022522S
4SVAS022752S

M
L
XL
XXL



Camice chirurgico specialistico in TNT idrorepellente SMS gr/mq 50, protezione interna impermeabile anteriormente e sulle maniche con polsini in maglina cm 8 e doppia cucitura, girocollo con fettucce in cotone 100%, chiusura al collo regolabile con velcro, 4 cinture in vita per chiusura interna / esterna sovrapposta con cartoncino fermacintura.

This surgical specialist gown is made of water-repellent non-woven (weight 50 g / m²), inner waterproof protection available on the front and sleeves; with cotton cuffs 8 cm; with double-stitched; with 100% cotton loops for crew neck; with velcro closure neck adjustable; 4 belts at the waistline for internal / external closure.





BAG PER CAMPO OPERATING THEATRE SET

2SVAS1AP0762

TELO | DRAPE
4SVAS202031K

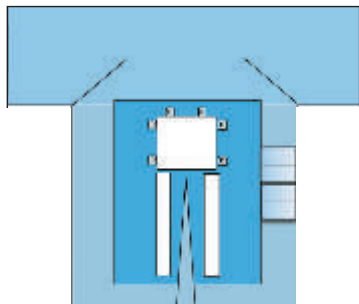

composizione Kit	pz.	Kit composition	pzc.
Telo tavolo madre	1	Drape	1
Telo cardiovascolare a "t" 230 x 320 cm	1	Cardiovascular "T" drape 230 x 320 cm	1
Telo 150 x 150 cm	1	Drape 150 x 150 cm	1
Telo 200 x 200 cm	1	Drape 200 x 200 cm	1
Telo 100 x 200 cm	1	Drape 100 x 200 cm	1
Telo 75 x 90 cm con adesivo	1	Drape 75 x 90 cm adhesive side	4
Calzare	2	Footwear	2
Telo tavolo mayo 80 x 145 cm	1	Drape mayo 80 x 145 cm	1
Sacca portastrumenti + adesivo	3	Instruments bags with adhesive side	3
Camice chirurgico xl hp	3	Surgical gown hp - size xl	3
Medicazione 10 x 30 cm	4	Adhesive plaster 10 x 30 cm	4
Medicazione 10 x 35 cm	1	Adhesive plaster 10 x 35 cm	1
Bende elastiche 10 x 450 cm	2	Elastic bandage 10 x 450 cm	2
Guanti chirurgici mis. 7	4	Surgical gloves size 7	4
Guanti chirurgici mis. 7,5	5	Surgical gloves size 7,5	5
Guanti chirurgici mis. 8	3	Surgical gloves size 8	3
Contenitore x suture	1	Suture bag	1
Manipolo x elettrobisturi	1	Electrosurgical knife	1
Spugnetta elettrobisturi	1	Electrosurgical knife sponge	1
Tamponi laparotomici 30 x 30 cm	50	Lap sponges 30 x 30 cm	50
Tamponi laparotomici 10 x 60 cm	50	Lap sponges 10 x 60 cm	50
Tamponi laparotomici 20 x 20 cm	50	Lap sponges 20 x 20 cm	50
Siringa 5 ml	1	Syringe 5 ml	1
Siringa 10 ml	2	Syringe 10 ml	2
Siringa 20 ml	2	Syringe 20 ml	2
Siringa 60 ml	1	Syringe 60 ml	1
Lama bisturi fig. 11	2	Scalpel fig 11	2
Lama bisturi fig. 24	2	Scalpel fig 24	2
Cannula yankauer	1	Yankauer canula	1
Tubo collegamento	1	Connecting tube	1
Ciotola 250 ml	3	Plastic bowl 250 ml	3
Ciotola 500 ml	1	Plastic bowl 500 ml	1
Velcro	4	Velcro	4
Copertura manico lampada scialitica	1	Lamp cover handle	1
Vassoio	1	Tray	1



BAG VENA CENTRALE CENTRAL VEIN SET

composizione Kit / Kit composition pz. / pcs.

Telo tavolo madre	1
Telo 100 x 150 cm	1
Guanti chirurgici mis. 7	2
Porta aghi monouso in acciaio	1
Sutura in seta	1
Medicazione trasparente 5 x 7,5 cm	1
Tamponi rotondi	10
Compresse garza 10 x 10 cm	10
Siringa 5 ml + ago g 22	1
Siringa 20 ml	1
Rubinetti 3 vie	3
Ciotola 250 ml	1
Spugna con manico per disinfezione cute	1



2SVAS1AP0762

<i>Drape</i>	<i>1</i>
<i>Drape 100 x 150 cm</i>	<i>1</i>
<i>Surgical gloves size 7</i>	<i>2</i>
<i>Mayo hegar needle holder single use</i>	<i>1</i>
<i>Silk suture</i>	<i>1</i>
<i>Adhesive plaster 5 x 7,5 cm</i>	<i>1</i>
<i>Gauze ball</i>	<i>10</i>
<i>Gauze swabs 10 x 10 cm</i>	<i>10</i>
<i>Syringe 5 ml with needle 22g</i>	<i>1</i>
<i>Syringe 20 ml</i>	<i>1</i>
<i>Stopcock 3 ways</i>	<i>3</i>
<i>Plastic bowl 250 ml</i>	<i>1</i>
<i>Disinfection skin sponge with plastic handle</i>	<i>1</i>

BAG CATETERIRSMO VESCICALE VESCICAL CATHETERIZATION

composizione Kit / Kit composition pz. / pcs.

Telo tavolo madre	1
Guanti chirurgici 7,5	1
Acqua apirogena in fiale da 10 ml	1
Bustina da 25 ml di disinfettante a base di clorexidina	1
Catetere vescicale 16 fr.	1
Tamponi rotondi	10
Compresse garza 10 x 10 cm	5



2SVAS1AP0762

<i>Drape</i>	<i>1</i>
<i>Surgical gloves size 7,5</i>	<i>1</i>
<i>Apyrogenous water ampoule 10 ml</i>	<i>1</i>
<i>Clorexidine disinfectant sachet 25 ml</i>	<i>1</i>
<i>Vesical catheter 16 fr</i>	<i>1</i>
<i>Gauze ball</i>	<i>10</i>
<i>Gauze swabs 10 x 10 cm</i>	<i>5</i>



2SVAS1AP2780

TELO | DRAPE
4SVAS504561K

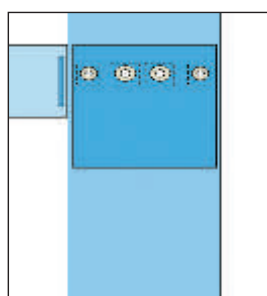

composizione Kit	pz.	Kit composition	pzc.
Telo tavolo madre 150 x 200 cm	1	Table cover 150x200 cm	1
Telo per copertura paziente con 4 fori, doppia banda laterale trasparente e tasca laterale per raccolta liquidi	1	Emo drape with 4 hole, double transparent pannell and lateral bag	1
Cuffia in pe trasparente con elastico 100 x 100 cm	1	Pe cover 100 x 100 cm	1
Cuffia in pe trasparente con elastico diam. 100 cm	1	Pe cover diam. 100 cm	1
Guaina copritelecamera 13 x 250 cm	1	Camera cover 13x250 cm	1
Coprimanico lampada scialitica	1	Light handle cover flexible	1
Sacchetto per rifiuti	1	Yellow waste bag	1
Confezioni da 10 compresse di garza 10 x 10 a 16 strati xr	4	X-ray gauze swab 10x10 cm (in packs of 10)	4
Camici chirurgici alta protezione mis. XI	3	Reinforced surgical gown xl	3
Salviette asciugamani assorbenti	4	Absorbent towel	4
Spugna con manico per la disinfezione della cute	1	Medical applicator	1
Bisturi con manico fig. 11	1	Scalpel n. 11	1
Siringa da 2,5 ml cono centrale luer	1	2,5 ml syringe slip tip	1
Siringa da 5 ml cono centrale luer lock	1	5 ml syringe luer lock tip	1
Siringa da 10 ml cono centrale luer codice colore rosso	1	10 ml syringe slip tip - red	1
Siringa da 10 ml cono centrale luer codice colore verde	1	10 ml syringe slip tip - green	1
Siringa da 10 ml cono centrale luer codice colore azzurro	1	10 ml syringe slip tip - blue	1
Siringa da 20 ml cono centrale luer	1	20 ml syringe slip tip	1
Siringa da 20 ml cono centrale luer lock	1	20 ml syringe luer lock tip	1
Ago ipodermico 27g	1	Hypodermic needle 27g	1
Aghi ipodermici 21g	2	Hypodermic needle 21g	2
Aghi ipodermici 22g	2	Hypodermic needle 22g	2
Contenitore per aghi usati	1	Container for used needle	1
Rubinetto a tre vie per alta pressione	1	3 way stopcock hp	1
Prolunga per alta pressione da 120 cm	1	Hp extension line 120 cm	1
Guida angiografica	1	Guidewire	1
Ago introduttore 18g x 70 mm	1	Introducer needle 18g x 70 mm	1
Ciotola azzurra graduata da 250 ml	1	Graduated bowl 250 ml	1
Ciotola azzurra graduata da 500 ml	1	Graduated bowl 500 ml	1
Ciotola azzurra graduata da 1000 ml	1	Graduated bowl 1000 ml	1
Ciotola grauata 3000 ml con tacche fermaguida angiografica	1	Graduated guidewire bowl 3000 ml	1



2SVAS1AP2781

TELO | DRAPE
4SVAS501101K

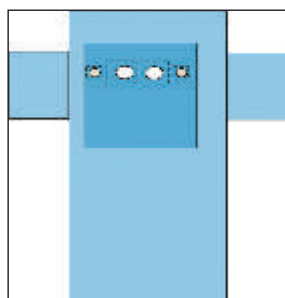

composizione Kit	pz.	Kit composition	psc.
Telo tavolo madre 150 x 200 cm	1	Table cover 150x200 cm	1
Telo per copertura paziente con 4 fori, doppia banda laterale trasparente e rinforzo sulle bande	1	Emo drape with 4 hole, double transparent pannel and lateral reinforce	1
Cuffia in pe trasparente con elastico 100 x 120 cm	1	Pe cover 100 x 120 cm	1
Cuffia in pe trasparente con elastico diam. 130 cm	1	Pe cover diam. 130 cm	1
Coprimanico lampada scialitica	1	Light handle cover flexible	1
Confezioni da 10 compresse di garza 10 x 10 a 16 strati xr	3	X-ray gauze swab 10x10 cm (in packs of 10)	3
Camici chirurgici alta protezione mis. XI	2	Reinforced surgical gown xl	2
Salviette asciugamani assorbenti	8	Absorbent towel	8
Spugna con manico per la disinfezione della cute	1	Medical applicator	1
Bisturi con manico fig. 11	1	Scalpel n. 11	1
Siringa da 2,5 ml cono centrale luer	1	2,5 ml syringe slip tip	1
Siringa da 5 ml cono centrale luer lock	1	5 ml syringe luer lock tip	1
Siringa da 10 ml cono centrale luer lock codice colore giallo	1	10 ml syringe slip tip - yellow	1
Siringa da 10 ml cono centrale luer lock codice colore verde	1	10 ml syringe slip tip - green	1
Siringa da 10 ml cono centrale luer lock codice colore azzurro	1	10 ml syringe slip tip - blue	1
Siringhe da 20 ml cono centrale luer lock	2	20 ml syringe luer lock tip	2
Aghi ipodermici 23g	3	Hypodermic needle 23g	3
Ago ipodermico 21g	1	Hypodermic needle 21g	1
Aghi ipodermici 22g	2	Hypodermic needle 22g	2
Contenitore per aghi usati	1	Container for used needle	1
Rampa di tre rubinetti a tre vie per alta pressione	1	High pressure manifold	1
Prolunga per alta pressione retinata da 120 cm	1	High pressure extension line 120 cm	1
Perforatore con valvola	1	Extension line with valve	1
Deflussore standard	1	Infusion set	1
Prolunga per bassa pressione da 150 cm	1	Low pressure extension line 120 cm	1
Siringa angiografica ad anelli da 12 ml	1	Angiography siryng	1
Guida angiografica	1	Guidewire	1
Ago introduttore 18g x 70 mm	1	Introducer needle 18g x 70 mm	1
Introduttore a bulbo per guida angiografica	1	Introducer bulb	1
Ciotola gialla graduata da 120 ml	1	Graduated bowl 120 ml - yellow	1
Ciotola trasparente graduata da 250 ml	1	Graduated bowl 250 ml - transparent	1
Ciotola rossa graduata da 500 ml	1	Graduated bowl 500 ml - red	1
Ciotola azzurra graduata da 1000 ml	1	Graduated bowl 1000 ml - blue	1
Vassoio con tacche fermaguida	1	Gudewire tray	1

► Sono state evidenziate solo alcune composizioni. È possibile approntare soluzioni e configurazioni a richiesta del cliente.
Here above have showed only some models. It is possible to realize any configuration the customer requires.



2SVAS1AP2782



composizione Kit	pz.	Kit composition	pzc.
Telo tavolo madre 100 x 150 cm	1	Table cover 100x150 cm	1
Cuffia in pe trasparente con elastico 100 x 100 cm	1	Pe cover 100 x 100 cm	1
Cuffie in pe trasparente con elastico diam. 100 cm	2	Pe cover diam. 100 cm	2
Confezioni da 10 compresse di garza 10 x 10 a 16 strati xr	3	X-ray gauze swab 10x10 cm (in packs of 10)	3
Salviette asciugamani assorbenti	4	Absorbent towel	4
Bisturi con manico fig. 11	1	Scalpel n. 11	1
Siringa da 2,5 ml cono centrale luer	1	2,5 ml syringe slip tip	1
Siringa da 10 ml cono centrale luer lock	1	10 ml syringe luer lock tip	1
Siringa da 20 ml cono centrale luer codice colore rosso	1	20 ml syringe slip tip - red	1
Siringa da 20 ml cono centrale luer codice colore azzurro	1	10 ml syringe slip tip - blue	1
Siringa da 20 ml cono centrale luer	1	20 ml syringe slip tip	1
Aghi ipodermici 22g	2	Hypodermic needle 22g	2
Aghi ipodermici 21g	2	Hypodermic needle 21g	2
Rampa di tre rubinetti a tre vie per alta pressione	1	High pressure manifold	1
Prolunga per alta pressione retinata da 100 cm	1	High pressure extension line 120 cm	1
Perforatore con valvola	1	Extension line with valve	1
Deflussore standard	1	Infusion set	1
Prolunga per bassa pressione da 120 cm	1	Low pressure extension line 120 cm	1
Siringa angiografica ad anelli da 12 ml	1	Angiography sirynges	1
Ago introduttore 18g x 70 mm	1	Introducer needle 18g x 70 mm	1
Ciotola gialla graduata da 120 ml	1	Graduated bowl 120 ml - yellow	1
Ciotola azzurra graduata da 250 ml	1	Graduated bowl 250 ml - blue	1
Ciotola azzurra graduata da 500 ml	1	Graduated bowl 500 ml - blue	1
Vassoio	1	Tray	1



2SVAS1AP2783

TELO | DRAPE
2SVAS0AP0415

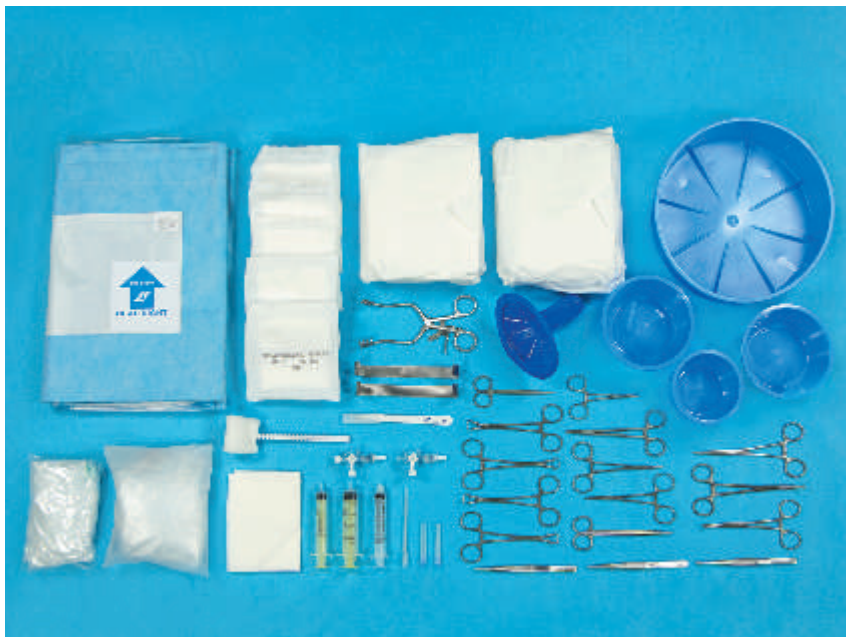
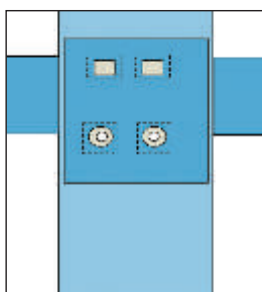

composizione Kit	pz.	Kit composition	pzc.
Telo tavolo madre 150 x 200 cm	1	Table cover 150x200 cm	1
Telo per copertura paziente con 4 fori, doppia banda laterale trasparente e rinforzo sulle bande	1	Pmk drape with 4 hole, double transparent pannell and lateral reinforce	1
Cuffia in PE trasparente con elastico 100 x 100 cm	1	Pe cover 100 x 100 cm	1
Cuffia in PE trasparente con elastico diam. 100 cm	1	Pe cover diam. 100 cm	1
Coprimanico lampada scialitica	1	Light handle cover flexible	1
Confezioni da 10 compresse di garza 10 x 10 a 16 strati xr	5	X-ray gauze swab 10x10 cm (in packs of 10)	5
Camici chirurgici alta protezione mis. XI	2	Reinforced surgical gown xl	2
Salviette asciugamani assorbenti	2	Absorbent towel	2
Spugna con manico per la disinfezione della cute	1	Medical applicator	1
Bisturi con manico fig. 11	1	Scalpel n. 11	1
Siringa da 10 ml cono centrale Luer Lock codice colore giallo	1	10 ml syringe luer lock tip - yellow	1
Siringa da 20 ml cono centrale Luer Lock codice colore giallo	1	20 ml syringe luer lock tip - yellow	1
Siringa da 10 ml cono centrale Luer Lock	1	10 ml syringe luer lock tip	1
Aghi ipodermici 22g	2	Hypodermic needle 22g	2
Rubinetto a tre vie per alta pressione	2	3 way stopcock hp	2
Divaricatore autostaico Weitlaner	1	Weitlaner retractor	1
Coppia di divaricatori Farabeuf	1	Coppia di divaricatori farabeuf	1
Forbici tipo Metzmbaum curva	1	Metzenbaum scissor curved	1
Porta aghi Mayo	1	Mayo hegar needle holder	1
Pinza tipo Klemmer	1	Klemmer forceps	1
Prolunga per alta pressione retinata da 120 cm	1	High pressure extension line 120 cm	1
Passafili Baby-mixer	1	Baby mixer	1
Pinza anatomica punte fini	1	Dressing forceps	1
Pinze chirurgiche 1/2 Theet	2	Tissue forceps	2
Pinze mosquito rette	2	Mosquito forceps	2
Pinza tipo Hartmann curva	1	Hartman forceps curved	1
Pinza Kocher curva	1	Kocher forceps curved	1
Pinze fermateli tipo Backaus	4	Backaus towel clamp	4
Forbici tipo Iris retta	1	Iris scissor	1
Ciotola azzurra graduata da 250 ml	1	Graduated bowl 250 ml - blue	1
Ciotole azzurre graduate da 500 ml	2	Graduated bowl 500 ml - blue	2
Ciotola azzurra graduata da 1000 ml	1	Graduated bowl 1000 ml - blue	1
Ciotola graduata 3000 ml con tacche fermaguida angiografica	1	Graduated guidewire bowl 3000 ml	1

► Sono state evidenziate solo alcune composizioni. È possibile approntare soluzioni e configurazioni a richiesta del cliente.
Here above have showed only some models. It is possible to realize any configuration the customer requires.





GINECOLOGIA
GYNAECOLOGY

Parto p. 26
Birth

Taglio Cesareo p. 27
C-Section



GINECOLOGIA
GYNAECOLOGY

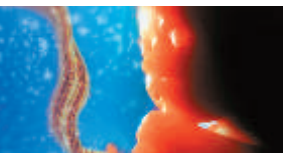

2SVAS0080203



composizione Kit	pz.	Kit composition	pzc.
Telo tavolo madre 100 x 150 cm	1	Table cover 100x150 cm	1
Paio di guanti chirurgici mis. 7	1	Surgical gloves 7	1
Paia di guanti chirurgici mis. 7,5	2	Surgical gloves 7,5	2
Paio di guanti chirurgici mis. 8	1	Surgical gloves 8	1
Tamponi rotondi diam. 40 mm con filo di bario	10	X-ray cotton balls	10
Confezioni da 10 compresse di garza 10 x 10 a 16 strati xr	3	X-ray gauze swab 10x10 cm (in packs of 10)	3
Siringa da 20 ml cono centrale luer	1	Syringe 20 ml luer slip	1
Forbici tipo Mayo retta	1	Mayo scissors	1
Catetere femminile Nelaton ch 14	1	Nelaton catheter ch 14	1
Pinzetta ombelicale	1	Cord clamp	1
Camice visitatore	1	Visitors gown	1
Traversa salvaletto 60x90 cm	1	Underpad 60 x 90 cm	1
Tubo per aspirazione chirurgica da 300 cm	1	Suction tubing 300 cm	1
Ciotola azzurra graduata da 250 ml	1	Graduated bowl 250 ml - blue	1
Vassoio	1	Tray	1

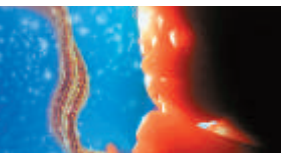

2SVAS1AP2784

TELO | DRAPE
4SVAS801061K

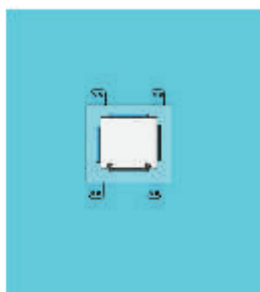

composizione Kit	pz.	Kit composition	psc.
Telo tavolo madre 100 x 150 cm	1	Table cover 100x150 cm	1
Telo per taglio cesareo con sacca raccolta liquidi	1	Caesarean drape with bag	1
Paio di guanti chirurgici mis. 6,5	1	Surgical gloves 6,5	1
Paia di guanti chirurgici mis. 7	1	Surgical gloves 7	1
Paio di guanti chirurgici mis. 8	1	Surgical gloves 8	1
Tamponi rotondi diam. 40 mm con filo di bario	20	X-ray cotton balls	20
Tamponi laparotomici 30x45 cm a 4 strati con filo di bario	20	X-ray lap sponge 30 x 45 cm	20
Busta per placenta	1	Placenta bag	1
Forbici tipo mayo retta	1	Mayo scissor	1
Bisturi con manico fig. 24	1	Scalpel n. 24	1
Sonda per aspirazione con valvola di controllo	1	Yankauer cannula	1
Pinzetta ombelicale	1	Cord clamp	1
Camice visitatore	1	Visitors gown	1
Traversa salvaletto 60x90 cm	1	Underpad 60 x 90 cm	1
Tubo per aspirazione chirurgica da 300 cm	1	Suction tubing 300 cm	1
Medicazione post-operatoria 10x25 cm	1	Post-operative dressing 10x25 cm	1
Manipolo per elettrobisturi	1	Electrosurgical knife	1
Ciotola da 120 ml	1	Graduated bowl 120 ml - blue	1
Vassoio	1	Tray	1





CHIRURGIA UROLOGICA
UROLOGY

Urologia
Urology

p. 30 / 31 / 32



CHIRURGIA UROLOGICA
UROLOGY



2SVAS1AP0717

TELO | DRAPE
4SVAS301092K

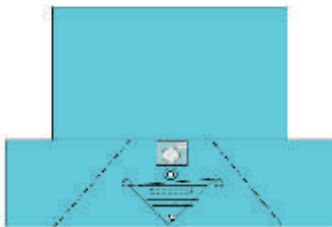

composizione Kit	pz.	Kit composition	pzc.
Telo tavolo madre 100 x 150 cm	1	Table cover 100x150 cm	1
Paia di guanti chirurgici mis. 7,5	2	Surgical gloves 7,5	2
Telo per urologia con gambali, foro e dito d'ispezione	1	Urology drape	1
Deflussore per urologia con due perforatori	1	Irrigation set	1
Tubo di scarico da 200 cm	1	Extension line 200 cm	1
Tubi di collegamento in silicone da 15 cm	2	Silicon tubing 15 cm	2
Paio di guanti chirurgici mis. 8	1	Surgical gloves 81	1
Disinfettante clorexidina	1	Clorexidina	1
Compresse di garza 10 x 10 a 16 strati	5	Gauze swab 10x10 cm	5
Spugna con manico per la disinfezione della cute	1	Medical applicator	1
Ciotola azzurra graduata da 250 ml	1	Graduated bowl 250 ml - blue	1
Vassoio	1	Tray	1



2SVAS1AP0718

TELO | DRAPE 4SVAS301092K

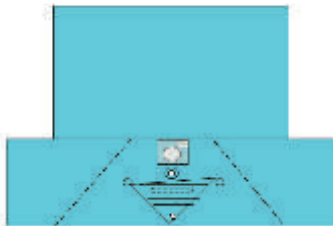

composizione Kit	pz.	Kit composition	pzc.
Telo tavolo madre 100 x 150 cm	1	Table cover 100x150 cm	1
Paia di guanti chirurgici mis. 7,5	2	Surgical gloves 7,5	2
Telo per urologia con gambali, foro e dito d'ispezione	1	Urology drape	1
Tubo di scarico da 200 cm	1	Extension line 200 cm	1
Telo sacco mayo 80x145 cm	1	Mayo drape 80x145 cm	1
Siringhe da 60 ml cono catetere	2	Syringe 60 ml luer	2
Spugna con manico per la disinfezione della cute	1	Medical applicator	1
Guaina copritelecamera in pe trasparente 13x250 cm	1	Camera cover 13x250 cm	1
Confezione da 10 compresse di garza 10 x 10 a 16 strati	1	X-ray gauze swab 10x10 cm (in packs of 10)	1
Camice chirurgico rinforzato mis. L	1	Reinforced surgical gown l	1
Camice chirurgico rinforzato mis. XI	1	Reinforced surgical gown xl	1
Disinfettante clorexidina	1	Clorexidina	1
Strisce in velcro da 15 cm	2	Tube holder 15 cm	2
Ciotola azzurra graduata da 250 ml	1	Graduated bowl 250 ml - blue	1
Vassoio	1	Tray	1



2SVAS1AP0716



composizione Kit	pz.	Kit composition	pzc.
Telo tavolo madre 100 x 150 cm	1	Table cover 100x150 cm	1
Telino per incisione	1	Incision drape	1
Telo 100x100 con lato adesivo	1	Adhesive drape 100 x 100 cm	1
Teli 150x180 con lato adesivo	2	Adhesive drape 150 x 180 cm	2
Telo sacco mayo 80x145 cm	1	Mayo drape 80x145 cm	1
Teli 75x90 con lato adesivo	4	Adhesive drape 75 x 90 cm	4
Spugna con manico per la disinfezione della cute	1	Medical applicator	1
Bisturi con manico fig. 11	1	Scalpel n. 11	1
Confezione da 10 compresse di garza 10 x 10 a 16 strati	1	X-ray gauze swab 10x10 cm (in packs of 10)	1
Camice chirurgico rinforzato mis. L	1	Reinforced surgical gown l	1
Camici chirurgici rinforzati mis. XI	2	Reinforced surgical gown xl	2
Disinfettante clorexidina	1	Clorexidina	1
Tamponi rotondi diam. 12 mm con filo di bario	3	X-ray cotton balls	3
Salviette asciugamani 40x50 cm	2	Absorbent towel	2
Manico per elettrobisturi	1	Electrosurgical knife	1
Ciotola azzurra graduata da 250 ml	1	Graduated bowl 250 ml - blue	1
Vassoio	1	Tray	1



CHIRURGIA ORTOPEDICA
ORTHOPEDIC

Chirurgia Anca p. 34
Hip Set

Kit Universale p. 35
Universal Kit



CHIRURGIA ORTOPEDICA
ORTHOPEDIC



2SVAS1AP2785

TELO | DRAPE
4SVAS410191K

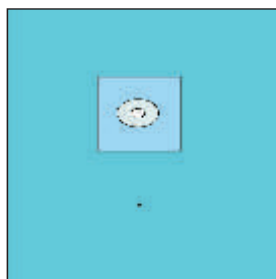

composizione Kit	pz.	Kit composition	pzc.
Telo tavolo madre 150 x 200 cm	1	Table cover 150x200 cm	1
Telo ad "u" con adesivo e rinforzo	1	"U" drape	1
Telo per anca con foro elastico	1	Hip drape with elastic hole	1
Stockinette 22x75 cm	1	Stockinette 30x120 cm	1
Telo sacco mayo 80x145 cm	1	Mayo drape 80x145 cm	1
Salviette asciugamani 40x50 cm	2	Absorbent towel	2
Strisce adesive 10x50 cm	4	Op-tape 10 x 50 xm	4
Camice chirurgico rinforzato mis. L	1	Reinforced surgical gown l	1
Camice chirurgico rinforzato mis. XI	1	Reinforced surgical gown xl	1
Striscia in velcro da 15 cm	1	Tube holder 15 cm	1



2SVAS1AP2429



composizione Kit	pz.	Kit composition	psc.
Telo tavolo 150 x 200 cm	1	Table cover 150 x 200 cm	1
Teli 150 x 200 con lato adesivo	2	Adhesive drape 150 x 200 cm	2
Teli 75 x 90 con lato adesivo	2	Adhesive drape 75 x 90 cm	2
Teli 150 x 240 con lato adesivo	1	Adhesive drape 150 x 240 cm	1
Strisce adesive 10 x 50 cm	2	Op-tape 10 x 50 cm	2
Telo sacco mayo 80x145 cm	1	Mayo drape 80x145 cm	1
Telo 75 x 90 cm	1	Drape 75 x 90 cm	1
Tasca portastrumenti con adesivo	1	Adhesive bag	1





CHIRURGIA GENERALE
GENERAL SURGERY

Pronto Soccorso
First Aid

p. 38

Dialisi
Dialysis

p. 40

Medicazione
Dressing Set

p. 39

Catetere Venoso Centrale **p. 41**
Central Venous Catheter



CHIRURGIA GENERALE
GENERAL SURGERY



PRONTO SOCCORSO FIRST AID

composizione Kit / Kit composition	pz. / pcs.
Telo tavolo 50x50 cm	1
Telino paziente 50x50 cm	1
Paio di guanti in lattice mis. M	1
Compresse di garza 10 x10 ad 8 strati	4
Bisturi con manico fig. 15	1
Teli 75x90 con lato adesivo	4
Pinza anatomica punte fini	1
Pinza chirurgica 1/2 theet	1
Porta aghi mayo	1
Forbici mayo retta	1
Pinza mosquito	2
<i>Table cover 50x50 cm</i>	<i>1</i>
<i>Drape 50x50 cm</i>	<i>1</i>
<i>Latex examination gloves</i>	<i>1</i>
<i>Gauze swab 10x10 cm</i>	<i>4</i>
<i>Scalpel n. 15</i>	<i>1</i>
<i>Adhesive drape 75x90 cm</i>	<i>4</i>
<i>Dressing forceps</i>	<i>1</i>
<i>Tissue forceps</i>	<i>1</i>
<i>Mayo hegar needle holder</i>	<i>1</i>
<i>Mayo scissor</i>	<i>1</i>
<i>Mosquito forceps</i>	<i>2</i>

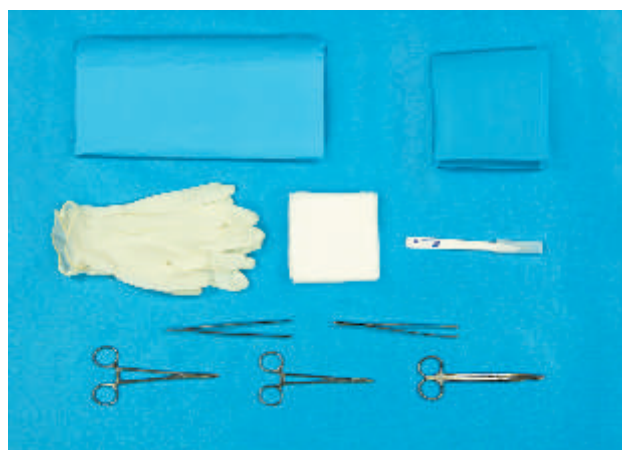

2SVAS1AP1511

SUTURA SUTURE

composizione Kit / Kit composition	pz. / pcs.
Telo tavolo 50x50 cm	1
Telino paziente 50x50 cm con foro adesivo diam. 10 cm	1
Tamponi rotondi diam. 30 cm	2
Compresse di garza 10x10 ad 8 strati con filo di bario	4
Sacchetto rifiuti	1
Cerotto in tnt 2,5 cm x 9,14 mt	1
Pinza anatomica punte fini	1
Porta aghi mayo	1
Forbici mayo retta	1
<i>Table cover 50x50 cm</i>	<i>1</i>
<i>Drape 50x50 cm with adhesive hole diam. 10 cm</i>	<i>1</i>
<i>X-ray cotton balls</i>	<i>2</i>
<i>Gauze swab 10x10 cm</i>	<i>4</i>
<i>Yellow waste bag</i>	<i>1</i>
<i>Adhesive tape 2,5 cm x 9,14 mt</i>	<i>1</i>
<i>Dressing forceps</i>	<i>1</i>
<i>Mayo hegar needle holder</i>	<i>1</i>
<i>Mayo scissor</i>	<i>1</i>

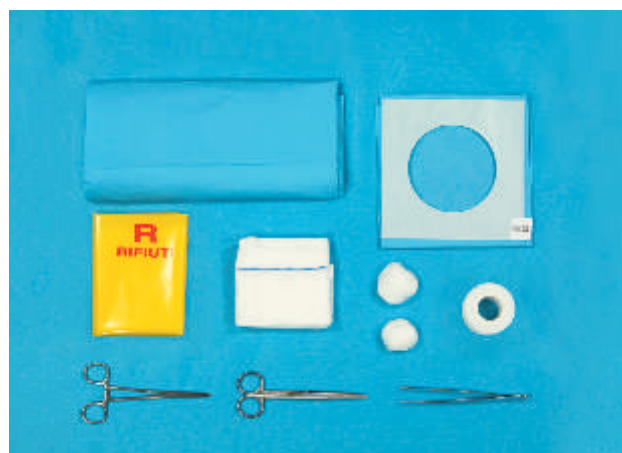

2SVAS1AP0407



MEDICAZIONE DRESSING SET

composizione Kit / Kit composition pz. / pcs.

Telo tavolo 50x50 cm	1
Telino paziente 50x50 cm	1
Compresse di garza 10x10 ad 8 strati	5
Paio di guanti in lattice mis. M	1
Pinza chirurgica 1/2 theet	1
Porta aghi mayo	1
Forbici mayo retta	1

<i>Table cover 50x50 cm</i>	<i>1</i>
<i>Drape 50x50 cm</i>	<i>1</i>
<i>Gauze swab 10x10 cm</i>	<i>5</i>
<i>Latex examination gloves</i>	<i>1</i>
<i>Tissue forceps</i>	<i>1</i>
<i>Mayo hegar needle holder</i>	<i>1</i>
<i>Mayo scissor</i>	<i>1</i>



2SVAS1AP2087

MEDICAZIONE DRESSING SET

composizione Kit / Kit composition pz. / pcs.

Telo tavolo 50x50 cm	1
Telino paziente 50x50 cm	1
Compresse di garza 10x10 ad 8 strati	5
Paio di guanti in lattice mis. M	1
Pinza klemmer	1
Porta aghi mayo	1
Forbici metzenbaum retta	1

<i>Table cover 50x50 cm</i>	<i>1</i>
<i>Drape 50x50 cm</i>	<i>1</i>
<i>Gauze swab 10x10 cm</i>	<i>5</i>
<i>Latex examination gloves</i>	<i>1</i>
<i>Klemmer forceps</i>	<i>1</i>
<i>Mayo hegar needle holder</i>	<i>1</i>
<i>Metzenbaum scissor</i>	<i>1</i>



2SVAS1AP0483



DIALISI
DIALYSIS

composizione Kit / Kit composition pz. / pcs.

Bende premifistola 5x45 cm	2
Salviettina disinfettante	1
Tamponi per emostasi diam. 25 mm	2
Paio di guanti in lattice mis. M	1
Traversa assorbente 40x60 cm	1
Strisce di cerotto adesivo in tnt	4

<i>Fistula bandage 5x45 cm</i>	2
<i>Disinfectant swab</i>	1
<i>Haemostatic swab</i>	2
<i>Latex examination gloves</i>	1
<i>Underpad 40x60 cm</i>	1
<i>Adhesive strip</i>	4



2SVAS1AP0971

DIALISI
DIALYSIS

composizione Kit / Kit composition pz. / pcs.

Bende premifistola 5x45 cm	2
Salviettina disinfettante	1
Tamponi per emostasi diam. 37 mm	2
Compresse di garza 18x40 cm	3
Laccio emostatico	1
Strisce di cerotto adesivo in tnt	4
Telino 50x50 cm	1
Vassoio reniforme	1

<i>Fistula bandage 5x45 cm</i>	2
<i>Disinfectant swab</i>	1
<i>Haemostatic swab</i>	2
<i>Gauze swab 18x40 cm</i>	3
<i>Torniquet</i>	1
<i>Adhesive strip</i>	4
<i>Drape 50x50 cm</i>	1
<i>Kidney tray</i>	1



2SVAS1AP1544



CATETERE VENOSO CENTRALE CENTRAL VENOUS CATHETER

2SVAS1AP0313



composizione Kit	pz.	Kit composition	psc.
Telo tavolo 75x90 cm	1	Table cover 75 x 90 cm	1
Teli 75x90 cm	3	Drape 75 x 90 cm	3
Telo 75x75 con foro adesivo 15x15 cm	1	Drape 75 x 75 cm with adhesive hole 15 x 15 cm	1
Disinfettante iodopovidone da 20 ml	1	Iodopovidone 20 ml	1
Fiala di lidocaina da 10 ml	1	Lidocaine 10 ml	1
Sutura seta 2/0 con ago triangolare	1	Suture silk	1
Spugna con manico per la disinfezione della cute	1	Medical applicator	1
Siringhe da 10 ml con ago 22 g	1	Syringe 10 ml luer slip with needle 22g	1
Compresse di garza 10 x 10 a 16 strati con filo di bario	10	Gauze swab 10x10 cm	10
Paio di guanti in lattice mis. M	1	Latex examination gloves	1
Forbici mayo retta	1	Mayo scissor	1
Porta aghi mayo	1	Mayo hegar needle holder	1
Mascherina con elastici	1	Surgeon face mask	1
Cuffia rotonda con elastico	1	Charlottes	1
Camice chirurgico standard mis. XI	1	Standard surgical gown xl	1
Ciotola azzurra graduata da 250 ml	1	Graduated bowl 250 ml - blue	1
Vassoio	1	Tray	1





STUMENTARIO CHIRURGICO
SURGICAL INSTRUMENTS



STRUMENTARIO CHIRURGICO MONOUSO DISPOSABLE SURGICAL INSTRUMENTS

PINZA PUNTE FINI
THUMB DRESSING



PINZA CHIRURGICA
TISSUE FORCEPS



PORTA AGHI
MAYO - HEGAR NEEDLE HOLDERS



KLEMMER
HAEMOSTATIC ROCHESTER PEAN



FORBICI PUNTE SMUSSA/ACUTA
MAYO SCISSORS



KELLY RETTA
KELLY FORCEPS





STRUMENTARIO CHIRURGICO MONOUSO DISPOSABLE SURGICAL INSTRUMENTS

KOCHER
KOCHER FORCEPES



LITTAUER
LIGATURE SCISSORS



FERMATELI BACKHAUS
BACKHAUS TOWEL CLAMP



MOSQUITO
MOSQUITO



FORBICI IRIS
IRIS SCISSOR



FORBICI METZENBAUM CURVA
METSENBAUM SCISSORS CURVED





STRUMENTARIO CHIRURGICO MONOUSO DISPOSABLE SURGICAL INSTRUMENTS

KOCHER CURVA
KOCHER FORCEPS CURVED



PASSAFILI BABY MIXTER
BABY MIXTER



DIVARICATORI FARABEU
FARABEU RETRACTORS



DIVARICATORE GELPI
GELPI RETRACTORS



DIVARICATORE WEITLANER
WEITLANER RETRACTORS



PINZA AD ANELLI
FOERSTER FORCEPS





STRUMENTARIO CHIRURGICO MONOUSO DISPOSABLE SURGICAL INSTRUMENTS

PINZA TIPO MARTIN CM. 25
UTERIN TENTACULUM FORCEPS CM. 25



CURETTE UTERINE
UTERINE CURETTES SHARP



ISTEROMETRO CM. 32
UTERINE SOUNDS MALLEABLE CM. 32



OTTURATORE
FILLING INSTRUMENTS



ESTIRPATORI
DENTAL FORCEPS





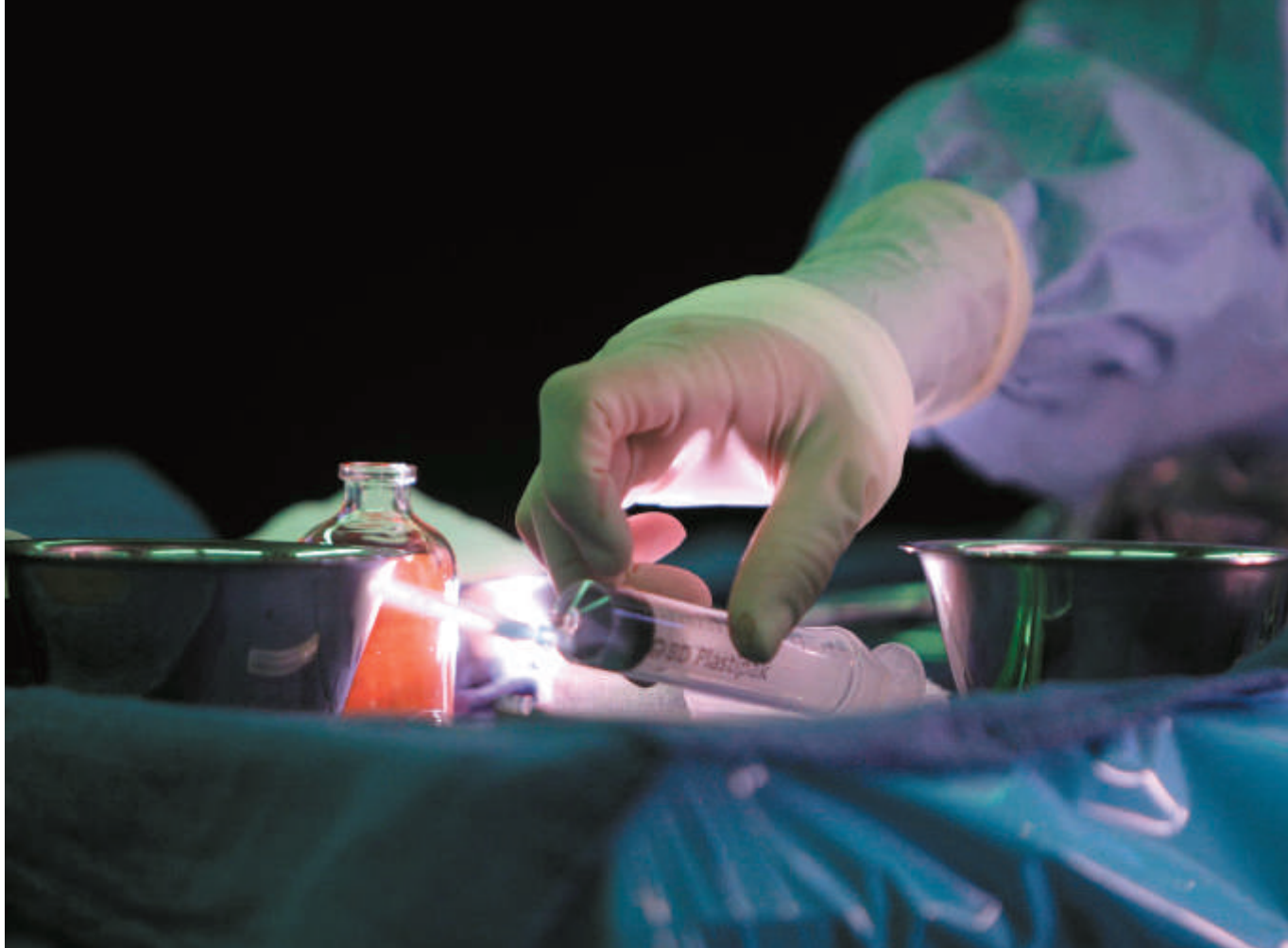

SIRINGHE E AGHI
SYRINGES AND NEEDLES



SIRINGHE E AGHI | SYRINGES AND NEEDLES

SIRINGA DA 10 ML CONO LUER LOCK
10 ML SYRINGE LUER LOCK



SIRINGA DA 20 ML CONO LUER ECCENTRICO
20 ML SYRINGE LUER ECCENTRIC



SIRINGA DA 20 ML CONO LUER CENTRALE
20 ML SYRINGE LUER CENTRAL



SIRINGA DA 10 ML CONO LUER LOCK
10 ML SYRINGE LUER LOCK



SIRINGA DA 10 ML CONO LUER ECCENTRICO
10 ML SYRINGE LUER ECCENTRIC



SIRINGA DA 10 ML CONO LUER CENTRALE
10 ML SYRINGE LUER CENTRAL





SIRINGHE E AGHI | SYRINGES AND NEEDLES

SIRINGA DA 1 ML
1 ML SYRINGE



SIRINGA DA 2 ML CONO LUER LOCK
2 ML SYRINGE LUER LOCK



SIRINGA DA 2,5 ML
2,5 ML L/S SYRINGE



SIRINGA DA 5 ML
5 ML L/S SYRINGE



AGHI MONOUSO IPODERMICI
HYPODERMIC NEEDLES



AGO ANGIOGRAFICO
ANGIOGRAPHIC NEEDLE





SIRINGHE E AGHI | SYRINGES AND NEEDLES

SIRINGA 10 ML CONO LUER LOCK
Codice colore Azzurro, Rosso, Verde, Giallo

10 ML SYRINGE COLORED - LUER LOCK
Color code Blue, Red, Green, Yellow



SIRINGA 10 ML CONO LUER
Codice Colore Azzurro, Rosso, Verde, Giallo

10 ML SYRINGE COLORED - LUER
Color code Blue, Red, Green, Yellow



SIRINGA 20 ML CONO LUER LOCK
Codice colore Azzurro, Rosso, Verde, Giallo

20 ML SYRINGE COLORED - LUER LOCK
Color code Blue, Red, Green, Yellow





SIRINGHE E AGHI | SYRINGES AND NEEDLES

SIRINGA 20 ML CONO LUER
Codice colore Azzurro, Rosso, Verde, Giallo

20 ML SYRINGE COLORED - LUER
Color code Blue, Red, Green, Yellow

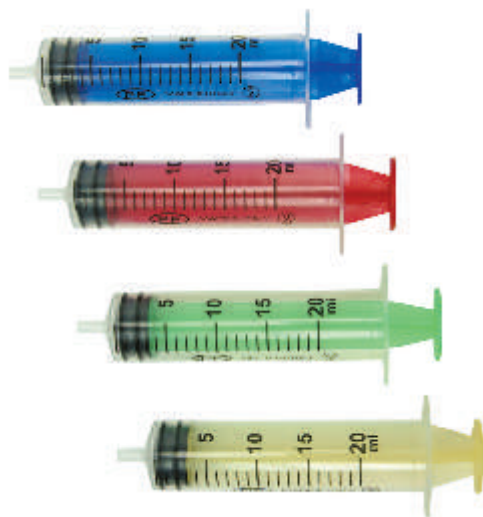

SIRINGA 10 ML CONO LUER LOCK
Codice colore Azzurro, Rosso

10 ML SYRINGE COLORED - LUER LOCK
Color code Blue, Red

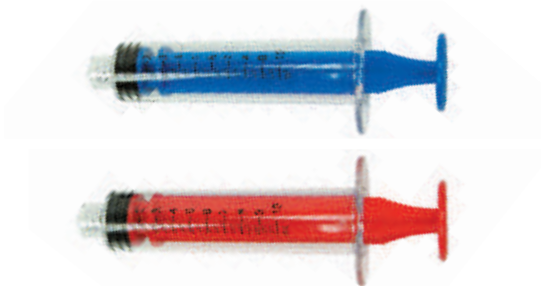

SIRINGA ANGIOGRAFICA AD ANELLI
CONTROL SYRINGES FINGERS RINGS



SIRINGA ANGIOGRAFICA CON MANICO A SELLA
CONTROL SYRINGES PALM PAD







GARZE E MEDICAZIONI
DRESSING



GARZE E MEDICAZIONI | DRESSING

COMPRESSE PIEGATE DI GARZA
SWABS



COMPRESSE IN TNT
SWABS NON WOVEN



TAMPONI LAPAROTOMICI
SWABS X RAY DETECTABLE



COMPRESSE PIEGATE DI GARZA CON FILO DI BARIO
SWABS X RAY DETECTABLE



TAMPONI DI GEL
FOAMCUBES



COMPRESSE POST OPERAZIONE
ADESIVE POST DRESSING

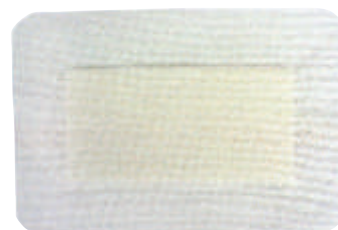



GARZE E MEDICAZIONI | DRESSING

TAMPONE ROTONDO DI GARZA
COTTON WOOL BALLS



TAMPONE ROTONDO DI GARZA CON FILO DI BARIO
COTTON WOOL BALLS X RAY DETECTABLE



DISPOSITIVO PER FISSAGGIO CANNULA ATTIVA IV FIX
ADHESIVE CATHETER DRESSING



BENDA ELASTICA
ELASTIC BANDAGE



MEDICAZIONE ADESIVA TRASPARENTE
ADHESIVE TRASPARENT WOND DRESSING SEVERAL

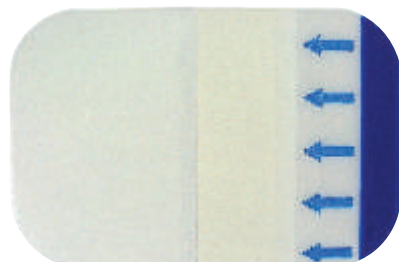





CIOTOLE E VASSOI
BOWLS AND TRAYS



CIOTOLE EVASSOI | BOWLS AND TRAYS

CIOTOLE GRADUATE

Codice colore Azzurro, Rosso, Giallo, Trasparente

SPONGE BOWLS GRADUATED

Color code Blue, Red, Yellow, Transparent

CAPACITÀ MASSIMA | MAX CAPACITY

120 ml

250 ml

500 ml

1000 ml



VASCHETTA RETTANGOLARE PICCOLA TRAY



VASSOIO TRAYS OEM



VASCHETTA RETTANGOLARE GRANDE TRAY



VASSOIO PER LAVAGGIO GUIDA GUIDEWIRE TRAY





CIOTOLE EVASSOI | BOWLS AND TRAYS

VASSOIO MULTISCOMPARTI
MULTISECTION TRAY



BACINELLA PER GUIDA ANGIOGRAFICA
GUIDEWIRE BOWL



BACINELLA GRADUATA
SPONGE BOWLS GRADUATED



BICCHIERE GRADUATO DA ML. 60
GALLIPOT 60 ML.



BACINELLA CON ADDENSANTE PER LIQUIDI
BOWL WITH COAGULATOR
POWDER FOR ORGANIC LIQUID



BACINELLA RENIFORME
KIDNEY DISH







ACCESSORI PER CAMPO OPERATORIO
ACCESSORIES

MASCHERINA
LATEX BROWN SURGICAL MASK



GUANTI CHIRURGICI IN LATTICE
LATEX BROWN SURGICAL GLOVES



GUANTI CHIRURGICI IN LATTICE
LATEX SURGICAL GLOVES



GUANTI DI FILO BIANCO
KNITTED GLOVES



GUANTI IN LATTICE
LATEX GLOVES



COPPIA DI TAMPONI PER EMOSTASI Ø 37
HEMOSTASIS PADS Ø 37





ACCESSORI PER CAMPO OPERATORIO ACCESSORIES

COPPIA DI TAMPONI PER EMOSTASI Ø 25
HEMOSTASIS PADS Ø 25



COPPIA DI BENDE PREMIFISTOLA
FISTULA BANDAGES



CONTENITORE PER SUTURE
SUTURE BOOTS

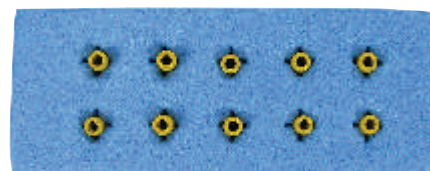

LOOPS TUBO ELASTICO
VESSEL LOOPS SILICON



PIASTRA ORGANIZER
ORGANIZER



PUNCH AORTICO
AORTIC PUNCH





ACCESSORI PER CAMPO OPERATORIO ACCESSORIES

FETTUCCIA IN COTONE
COTTON RIBBON



FALDA EMOSTATICA
HAEMOSTATIC FOAM



ELETTRODO A VENTOSA
SUCTION PAD ELECTRODE



BISTURI CON MANICO IN PLASTICA
SCALPEL



TAMPONE CON MANICO
SPONGE STIK MEDIUM



LAMA PER BISTURI
BALDE





ACCESSORI PER CAMPO OPERATORIO ACCESSORIES

LAMA PER ELETTROBISTURI
BLADE ELECTROSURGICAL



MANIPOLO PER ELETTROBISTURI
ELECTROSURGICAL PENCIL



SPUGNETTA PER ELETTROBISTURI
TIP CLEANER

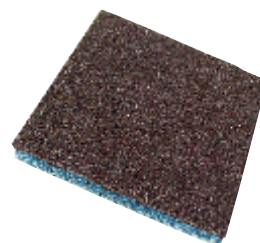

RASOIO PER TRICOTOMIA
TRICOTOMY RAZOR



CLOREXIDINA 25 ML / 0,15%



IODOPOVIDONE 10%





ACCESSORI PER CAMPO OPERATORIO ACCESSORIES

FAZZOLETTINO IMBEVUTO
DISPOSABLE CLEANING DISINFECTANT



PUFF BASTONCINO IN LEGNO
COTTON SMALL HEAD 15 CM.





DISPOSITIVI DI PROTEZIONE
DALLE RADIAZIONI
RADIATION PROTECTION DEVICES



DISPOSITIVI DI PROTEZIONE DALLE RADIAZIONI

RADIATION PROTECTION DEVICES

La Svas Biosana S.p.A. propone una linea di Dispositivi di Protezione dalle Radiazioni.

La linea comprende una gamma di dispositivi specificamente progettati per essere utilizzati come barriera di protezione dalle radiazioni secondarie emesse durante gli esami radiologici o gli interventi specialistici che utilizzano radiazioni ionizzanti. Tutti i dispositivi sono privi di piombo.

Svas Biosana S.p.A. offers a Radioprotection Medical Devices line. This line includes a full range of devices specifically designed to be used as barrier protection against secondary radiation emitted during radiological exams or specialist interventions that use ionizing radiation. All devices are lead-free.

RADIO GLOVES

GUANTI DI PROTEZIONE RADIATION PROTECTION GLOVES



Dispositivo monouso utilizzato per proteggere le mani degli operatori dalle radiazioni secondarie emesse durante le procedure e gli interventi specialistici che utilizzano raggi X.

La grande elasticità e la particolare forma anatomica assicurano un'eccellente sensibilità tattile.

Device disposable single used to protect the health workers' hands from the harmful secondary radiation exposure originating from the x-ray beam during radiological and interventional procedures.

Enhanced elasticity in connection with a close, figure-forming fit allows for a large degree of mobility.

RADIO GLOVES	Misura/Measure						
	6	6.5	7.0	7.5	8.0	8.5	9.0
	Codice/Code						
Bassa protezione/Low protection	3SVASPI20060	3SVASPI20065	3SVASPI20070	3SVASPI20075	3SVASPI20080	3SVASPI20085	3SVASPI20090
Media protezione/Medium protection	3SVASPI25060	3SVASPI25065	3SVASPI25070	3SVASPI25075	3SVASPI25080	3SVASPI25085	3SVASPI25090
Alta protezione/High protection	3SVASPI35060	3SVASPI35065	3SVASPI35070	3SVASPI35075	3SVASPI35080	3SVASPI35085	3SVASPI35090

I dispositivi sono sterili / The devices are sterile

RADIO EYES

PROTEZIONE PER OCCHI RADIATION PROTECTION EYES SHIELD



Dispositivo monouso utilizzato per proteggere la zona oculare dalle radiazioni durante gli esami radiologici effettuati a livello cranico o facciale.

Device disposable single used to protect the eye from the radiation during the head and facial CT scans.

Codice/Code	Misura/Measure	
	Lung/Lenght(mm)	Larg/Width(mm)
3SVASP235001	150	40



DISPOSITIVI DI PROTEZIONE DALLE RADIAZIONI

RADIATION PROTECTION DEVICES

RADIO THYROID

PROTEZIONE PER TIROIDE RADIATION PROTECTION THYROID SHIELD

Dispositivo monouso utilizzato durante gli esami radiologici per ridurre la dose di radiazione diretta alla ghiandola tiroidea e ai tessuti molli del collo.

Device disposable single used to save the radiation dose direct to the thyroid gland and the soft tissue of the neck during the radiological procedures.

Codice/Code	Misura/Measure	
	Lung/Lenght(mm)	Larg/Width(mm)
3SVASP335001	150	90



RADIO BREAST

PROTEZIONE PER MAMMELLE RADIATION PROTECTION PEDIATRICS SHIELD

Dispositivo utilizzato durante gli esami radiologici per ridurre la dose di radiazione diretta alle mammelle. L'utilizzo del dispositivo non produce una significativa variazione nella qualità dell'immagine radiologica.

Device used as barrier protection of the breast during scan CT to reduce the radiation exposure without significant changes in image quality.

Codice/Code	Misura/Measure	
	Lung/Lenght(mm)	Larg/Width(mm)
3SVASP435043	430	200
3SVASP435053	530	200



RADIO PEDIATRIC

PROTEZIONE PEDIATRICA RADIATION PROTECTION PEDIATRICS SHIELD

Dispositivo utilizzato per i pazienti pediatrici sottoposti ad esami radiologici allo scopo di ridurre la dose di radiazioni diretta al torace. L'utilizzo del dispositivo non produce una significativa variazione nella qualità dell'immagine radiologica.

Device used in pediatric age as barrier protection of the breast during scan CT to reduce the radiation exposure without significant changes in image quality.

Codice/Code	Misura/Measure	
	Lung/Lenght(mm)	Larg/Width(mm)
3SVASP535014	140	50
3SVASP535024	240	60
3SVASP535028	280	60
3SVASP535033	330	100





DISPOSITIVI DI PROTEZIONE DALLE RADIAZIONI RADIATION PROTECTION DEVICES

Teli monouso utilizzato come barriera di protezione dalle radiazioni disperse. Il dispositivo posizionato al di sopra del paziente, crea un cono d'ombra dalle radiazioni nel quale viene a trovarsi l'operatore

Medical Drapes single use, used as protection from Scattered X-Ray Radiation. The device positioned above the patient's, creates a shadow from radiation in which the operator is located.

RADIOPROTECTION MEDICAL DRAPES PER ANGIOGRAFIA CON APPROCCIO FEMORALE

RADIOPROTECTION MEDICAL DRAPES FOR FEMORAL ENTRY ANGIOGRAPHY SHIELD

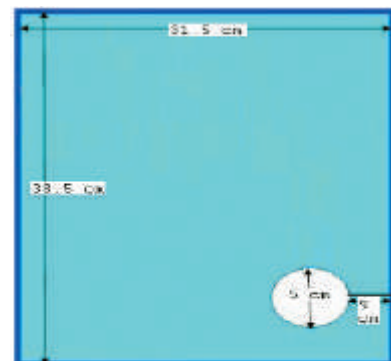

Codice/Code	Lung/Lenght(cm)	Larg/Width(cm)	Foro/Hole(cm)	Livello di protezione/Protection level
4SVAS5159GCS	38.5	31.5	5	Basso / Low (L)
4SVAS515IHCS	38.5	31.5	5	Medio / Medium (M)
4SVAS5152HCS	38.5	31.5	5	Alto / High (H)

RADIOPROTECTION MEDICAL DRAPES PER DIALISI CON FENESTRATURA 4"X9"

RADIOPROTECTION MEDICAL DRAPES FOR DIALYSIS WITH 4"X9" FENESTRATION

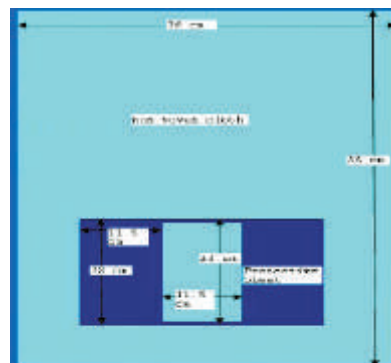

Codice/Code	Lung/Lenght(cm)	Larg/Width(cm)	Foro/Hole(cm)	Livello di protezione/Protection level
4SVAS1196T0S	36	36	11.25 x 23	Basso / Low (L)
4SVAS1197T0S	36	36	11.25 x 23	Medio / Medium (M)
4SVAS1198T0S	36	36	11.25 x 23	Alto / High (H)

RADIOPROTECTION MEDICAL DRAPES PER ENDO/UROLOGIA

RADIOPROTECTION MEDICAL DRAPES FOR ENDO/UROLOGY SPECILITY SHIELD

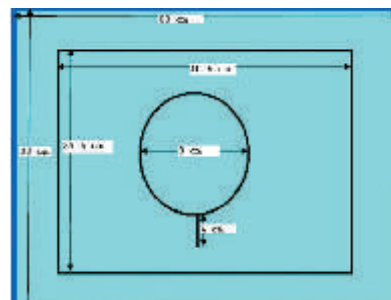

Codice/Code	Lung/Lenght(cm)	Larg/Width(cm)	Foro/Hole(cm)	Livello di protezione/Protection level
4SVAS30115CS	88	88	8	Basso / Low (L)
4SVAS30116CS	88	88	8	Medio / Medium (M)
4SVAS30117CS	88	88	8	Alto / High (H)



DISPOSITIVI DI PROTEZIONE DALLE RADIAZIONI RADIATION PROTECTION DEVICES

RADIOPROTECTION MEDICAL DRAPES PER BIOPSIA

RADIOPROTECTION MEDICAL DRAPES FOR BIOPSY SHIELD

Codice/Code	Lung/Lenght(cm)	Larg/Width(cm)	Foro/Hole(cm)	Livello di protezione/Protection level
4SVAS5093HCS	39.5	31.5	10 x 6.5	Basso / Low (L)
4SVAS5094HCS	39.5	31.5	10 x 6.5	Medio / Medium (M)
4SVAS5095HCS	39.5	31.5	10 x 6.5	Alto / High (H)

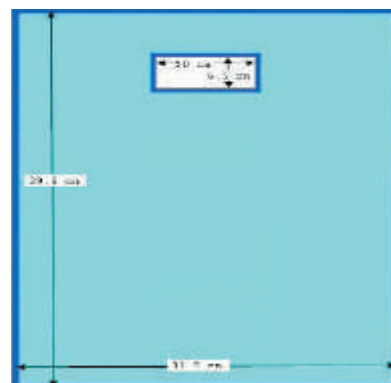

RADIOPROTECTION MEDICAL DRAPES PER INTERVENTI SPECIALISTICI

RADIOPROTECTION MEDICAL DRAPES FOR INTERVENTIONAL SPECIALITY SHIELD

Codice/Code	Lung/Lenght(cm)	Larg/Width(cm)	Livello di protezione/Protection level
4SVAS1029TCS	40.9	29.6	Basso / Low (L)
4SVAS1011VCS	40.9	29.6	Medio / Medium (M)
4SVAS1012VCS	40.9	29.6	Alto / High (H)

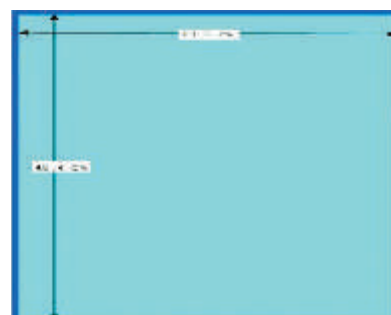

RADIOPROTECTION MEDICAL DRAPES PER SUCCLAVIA SINISTRA

RADIOPROTECTION MEDICAL DRAPES FOR EP LEFT SUBCLAVIAN SHIELD

Codice/Code	Lung/Lenght(cm)	Larg/Width(cm)	Foro/Hole(cm)	Livello di protezione/Protection level
4SVAS40933CS	40.4	30	7.5	Basso / Low (L)
4SVAS40934CS	40.4	30	7.5	Medio / Medium (M)
4SVAS40935CS	40.4	30	7.5	Alto / High (H)

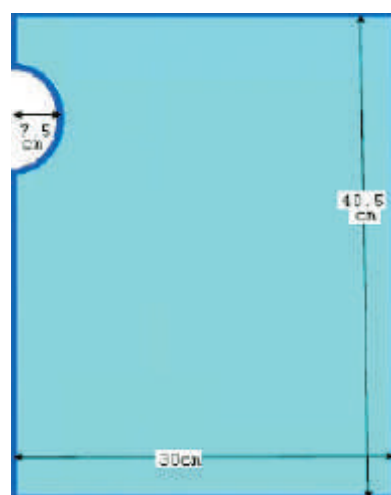



Tutti i diritti riservati
Copyright © 2019 Svas Biosana Spa

Impaginazione Grafica
Duva e Duva

Fotografie
Francesco D'Uva

finito di stampare
Ottobre 2014



direzione e uffici

Via Trentola, 7
80049
Somma Vesuviana (NA)
Italia

Divisione Medical

Via Genio Militare, 40
80044
Ottaviano (NA)
Italia

contatti

tel. +39 081 5289823
fax +39 081 8280875
www.svas.it
svas.biosana@svas.it